

# Möbel LETZ

*Finden und Wohlfühlen*



## Typenplan

3010.5 von Marlin - Gästebad in Anthrazit

### **Wichtiger Hinweis für Sie**

Etwaige Hinweise des Herstellers in dieser Produktinformation, die sich auf die Gewährleistung beziehen, haben für Sie keinerlei Bindungswirkung und können von Ihnen ignoriert werden. Ihre gesetzlichen Gewährleistungsrechte als Verbraucher uns gegenüber, als Ihrem Verkäufer, werden dadurch in keiner Weise berührt oder eingeschränkt. Sie können sich wegen aller Mängel jederzeit an uns wenden. Darüber hinaus gehende Herstellergarantien bleiben

Schlangen, Deutschland

Möbel Letz GmbH  
Am Gewerbepark 11  
06895 Zahna-Elster

Tel.: 035383 - 6018 50

Fax.: 035383 - 6018 17

# Marlin Gästebad 3010

## Marlin guest bathroom 3010



# Marlin Gästebad 3010

## Marlin guest bathroom 3010

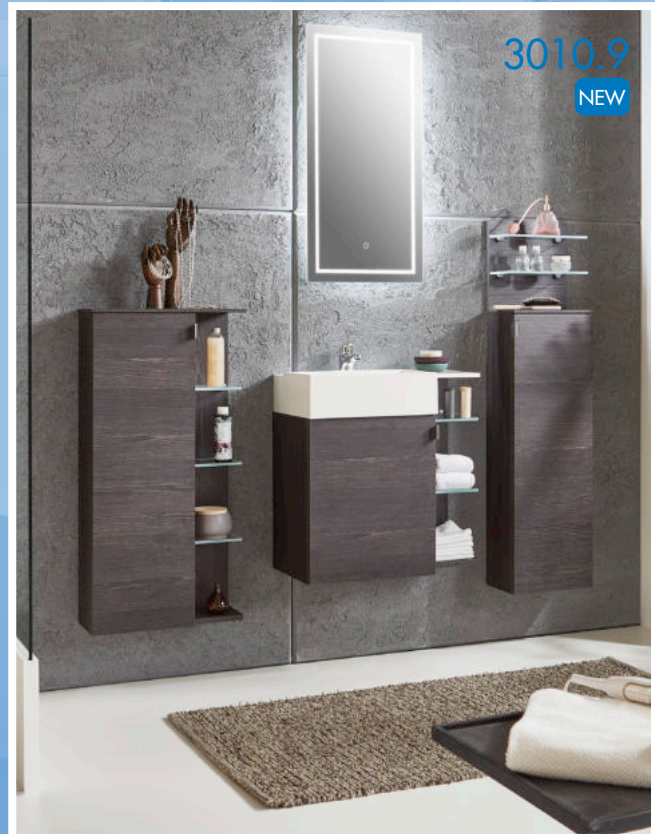

Piktogramme/pictograms



Mineralmarmor Waschtisch  
Marble minerals washbasin



LED Lichtfarbe kalt  
LED colour temperature cold



LED mit Bewegungssensor  
LED with motion sensor



Keramik Waschtisch  
Ceramic washbasin



LED Lichtfarbe warm  
LED colour temperature warm



LED mit Sensorschalter  
LED with sensor switch



Glas Waschtisch  
Glass washbasin

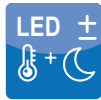

LED Lichtfarbe regelbar,  
Helligkeit dimmbar  
LED colour temperature adjust-  
able, brightness dimmable



LED Lichtfarbe schaltbar bzw. regelbar  
LED colour temperature adjustable

## Mineralmarmor Waschtisch weiß alpin Glanz (GB69) Marble minerals washbasin gloss alpine white (GB69)

≈ Beckenmaße in cm (BxHxT)  
basin dimensions in cm (WxHxD)

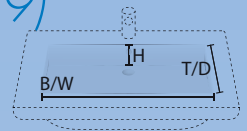

3010.1

MWGBS5 | 32,5 x 10 x 23 cm

Detail

## Glas Waschtisch weiß Glanz (GB79) Glass washbasin gloss white (GB79)



3010.1

GWGBS5 | 33 x 10 x 22 cm

Glasbecken links und rechts möglich. *Glas-basin left and right possible.*

Detail

## Mineralmarmor Waschtisch weiß alpin Glanz (GB69) Marble minerals washbasin gloss alpine white (GB69)



3010.2

MWGB06 | 54 x 10 x 21 cm

Detail

# »3010«

## Mineralmarmor Waschtisch weiß alpin Glanz (GB69) Marble minerals washbasin gloss alpine white (GB69)

 ≈ Beckenmaße in cm (BxHxT)  
basin dimensions in cm (WxHxD)

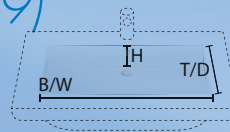

3010.3



MWGBS7 |  11 cm hoch/high



Detail

## Mineralmarmor Waschtisch weiß alpin Glanz (GB69) Marble minerals washbasin gloss alpine white (GB69)



3010.5



MWGBA6 |  35,7 x 10 x 30 cm

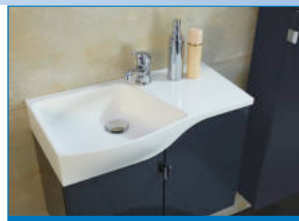

Detail

## Glas Waschtisch weiß Glanz (GB79) Glass washbasin gloss white (GB79)



3010.6



GWGBO5 |  33 x 11 x 26,5 cm  
Glasbecken links und rechts möglich. *Glas-basin left and right possible.*



Detail

## Mineralmarmor Waschtisch weiß alpin Glanz (GB69) Marble minerals washbasin gloss alpine white (GB69)

 ≈ Beckenmaße in cm (BxHxT)  
basin dimensions in cm (WxHxD)

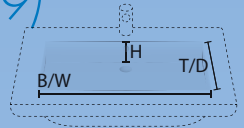

Detail

3010.7

MWGGB6 |  13 cm hoch/high

## Mineralmarmor Waschtisch weiß alpin Glanz (GB69) Marble minerals washbasin gloss alpine white (GB69)



Detail

3010.8

MWGBC6 |  Ø 23,5 cm x 10,9 cm hoch/high

## Mineralmarmor Waschtisch weiß alpin Glanz (GB69) Marble minerals washbasin gloss alpine white (GB69)



Detail

3010.9

MWGBD6 |  38 x 22 x 10,6 cm

## Schränke/cabinets

### Frontfarben/front colours

3010. 1, 2, 3, 5, 6, 7

MDF-foliert/MDF-coated

458



**Robinie Dunkel Nachbildung**  
*Robinia Dark Finish*  
GBJ\_

961



**Weiß Glanz**  
*Gloss White*  
GBG\_

273



**Eiche Struktur Nachbildung**  
*Oak Structure Finish*  
GBM\_

438



**Anthrazit Glanz**  
*Gloss Anthracite*  
GBF\_

### Korpusfarben/basic shell colours

3010. 1, 2, 3, 5, 6

PG 2

PG 3

488



**Robinie Dunkel Nachbildung**  
*Robinia Dark Finish*  
J/GB58

042



**Weiß Glanz Folie**  
*Gloss White*  
G/GB50

473



**Eiche Struktur Nachbildung**  
*Oak Structure Finish*  
M/GB55

438



**Anthrazit Glanz Folie**  
*Gloss Anthracite*  
F/GB30

### Korpusfarben/basic shell colours

3010.7

PG 2

488



**Robinie Dunkel Nachbildung**  
*Robinia Dark Finish*  
J/GB58

286



**Weiß Seidenglanz**  
*Silk Gloss White*  
E/GB86

473



**Eiche Struktur Nachbildung**  
*Oak Structure Finish*  
M/GB55

284



**Anthrazit Seidenglanz**  
*Silk Gloss Anthracite*  
A/GB84

## Schränke/cabinets

### Frontfarben/front colours

3010. 8, 9

#### Dickkante/thick edge

488



**Robinie Dunkel Nachbildung**  
Robinia Dark Finish  
GBO\_

286



**Weiß Seidenglanz**  
Silk Gloss White  
GBE\_

473



**Eiche Struktur Nachbildung**  
Oak Structure Finish  
GBL\_

284



**Anthrazit Seidenglanz**  
Silk Gloss Anthracite  
GBA\_

### Korpusfarben/basic shell colours

3010. 8, 9

#### PG 1

488



**Robinie Dunkel Nachbildung**  
Robinia Dark Finish  
J/GB58

286



**Weiß Seidenglanz**  
Silk Gloss White  
E/GB86

473



**Eiche Struktur Nachbildung**  
Oak Structure Finish  
M/GB55

284



**Anthrazit Seidenglanz**  
Silk Gloss Anthracite  
A/GB84

## Regalfarben/ shelf colours

287



**Weiß Seidenglanz**  
*Silk Gloss White*  
GB86

474



**Eiche Struktur Nachbildung**  
*Oak Structure Finish*  
GB55

285



**Anthrazit Seidenglanz**  
*Silk Gloss Anthracite*  
GB84

489



**Robinie Dunkel Nachbildung**  
*Robinia Dark Finish*  
GB58

## Griffe/handles

3010. 1, 6



**Chrom Glanz**  
*Gloss Chrome*  
173  
⌀—⌀ 320 mm

3010.2



**Chrom Glanz**  
*Gloss Chrome*  
330  
⌀—⌀ 16 mm

3010. 3, 5, 7, 8, 9



**Chrom Glanz**  
*Gloss Chrome*  
329  
⌀—⌀ 32 mm





⌀—⌀ = Bohrabstand/ hole spacing

## Armatur/amature

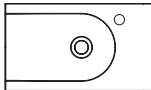
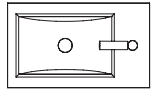

**MBSU**  
Einhebel-Waschtischarmatur chrom inkl.  
Zugstange und Befestigungsmaterial

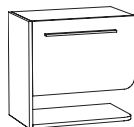
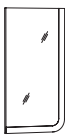
*single lever top, chrome incl. eccentric  
tappet and fastening materials*

Beschreibung Description	Maße in cm Dimensions in cm			Artikel-Nr. Article no.	Türanschlag Door stop	Identnummer ID number	
	B/W	H	T/D				
 <p><b>Mineralmarmor-Waschtisch</b> Ablage rechts inkl. Permanentablauf</p> <p><i>marble minerals washbasin</i> <i>depot on the right incl. permanent flow</i></p>	50,4	2	30	<b>MWGB55</b>			
 <p><b>Glas-Waschtisch</b> Becken links und rechts möglich inkl. Permanentablauf</p> <p><i>glass washbasin</i> <i>basin left and right possible</i> <i>incl. permanent flow</i></p>	50,4	1,2	30	<b>GWGB55</b>			
 <p>Raumsparsiphon</p> <p><i>basin siphon</i></p>				<b>RSS</b>			
 <p>Einhebel-Waschtischarmatur chrom inkl. Zugstange und Befestigungsmaterial</p> <p><i>single lever top, chrome</i> <i>incl. eccentric tappet and fastening</i> <i>materials</i></p>				<b>MBSU</b>			
						PG2 matt/matt	PG3 Glanz/gloss
 <p>Waschtisch-Unterschrank 1 Klappe, 1 offenes Fach</p> <p><i>washbasin base cabinet</i> <i>1 flap door, 1 open case</i></p>	50	47,8	29,8	<b>WMJK5</b>			
 <p>Spiegelpaneel LED Beleuchtung 10 W, satiniert 6000 Kelvin EEK A–A++</p> <p><i>mirror panel</i> <i>LED-lighting 10 W, satined</i> <i>6000 Kelvin EEC A–A++</i></p>	40	80	2,5	<b>SPLEA4</b>			
						PG2 matt/matt	PG3 Glanz/gloss
 <p>Mittelschrank 1 Tür, 1 offenes Fach, 2 Glaseinlegeböden, <b>nur Anschlag rechts möglich</b></p> <p><i>medium cabinet</i> <i>1 door, 1 open case, 2 glass boards</i> <i>only door stop right possible</i></p>	20	147	17,5	<b>MT2</b>	Rechts/ <i>right</i>		









EEK/EEC=Energieeffizienzklasse/energy efficiency category

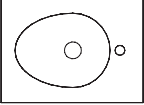









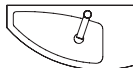

Beschreibung Description	Maße in cm Dimensions in cm			Artikel-Nr. Article no.	Türanschlag Door stop	Identnummer ID number	
	B/W	H	T/D			PG2 matt/matt	PG3 Glanz/gloss
 <p>Mineralmarmor-Waschtisch Ablage rechts inkl. Permanentablauf</p> <p>marble minerals washbasin depot on the right incl. permanent flow</p>	60,4	2/10	33	<b>MWGBA6</b>			
 <p>Raumsparsiphon</p> <p>basin siphon</p>				<b>RSS</b>			
 <p>Einhebel-Waschtischarmatur chrom inkl. Zugstange und Befestigungsmaterial</p> <p>single lever top, chrome incl. eccentric tappet and fastening materials</p>				<b>MBSU</b>			
 <p>Waschtisch-Unterschrank 2 Türen</p> <p>washbasin base cabinet 2 doors</p>	60	34,9/ 42,9	29,9	<b>WMMT6</b>			
 <p>Spiegelpaneel mit 3 Glasablagen rechts LED Beleuchtung 3,6 W, satiniert 6000 Kelvin EEK A-A++</p> <p>mirror panel with 3 glass shelves right LED-lighting 3,6 W, satined 6000 Kelvin EEC A-A++</p>	59	62/ 70	1,9/ 9,9	<b>SPRA6</b>			
 <p>Highboard inkl. Abdeckplatte 1 Tür 2 Glaseinlegeböden</p> <p>high cabinet incl. top 1 door 2 glass shelves</p>	30	91,2	17,6	<b>HBFT3FL</b> <b>HBFT3FR</b>	Links/left Rechts/right		
 <p>Highboard inkl. Abdeckplatte 1 Tür 2 Glaseinlegeböden</p> <p>high cabinet incl. top 1 door 2 glass shelves</p>	40	91,2	17,6	<b>HBFT4FL</b> <b>HBFT4FR</b>	Links/left Rechts/right		

EEK/EEC=Energieeffizienzklasse/energy efficiency category

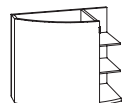
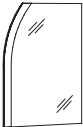
Beschreibung <i>Description</i>	Maße in cm <i>Dimensions in cm</i>			Artikel-Nr. <i>Article no.</i>	Türanschlag <i>Door stop</i>	Identnummer <i>ID number</i>	
	B/W	H	T/D				
 <p><b>Glas-Waschtisch</b> Becken links und rechts möglich inkl. Permanentablauf</p> <p><b>glass washbasin</b> <i>basin left and right possible</i> <i>incl. permanent flow</i></p> 	50,4	1,2	37,1	<b>GWGBO5</b>			
 <p>Raumsparsiphon</p> <p><i>basin siphon</i></p>				<b>RSS</b>			
 <p>Einhebel-Waschtischarmatur chrom inkl. Zugstange und Befestigungsmaterial</p> <p>single lever top, chrome incl. eccentric tappet and fastening materials</p>				<b>MBSU</b>			
						<b>PG2</b> matt/matt	<b>PG3</b> Glanz/gloss
 <p>Waschtisch-Unterschrank 1 Auszug</p> <p><i>washbasin base cabinet</i> <i>1 extension</i></p>	50	31,6	36,5	<b>WGGA5</b>			
 <p>Spiegelpaneel LED Beleuchtung 18 W, satiniert 6000 Kelvin EEK A-A++</p> <p><i>mirror panel</i> <i>LED-lighting 18 W, satined</i> <i>6000 Kelvin EEC A-A++</i></p> 	53	88	2,5	<b>SPLEC5</b>			
						<b>PG2</b> matt/matt	<b>PG3</b> Glanz/gloss
 <p>Highboard inkl. Abdeckplatte 1 Tür 2 Glaseinlegeböden <b>Griff senkrecht</b></p> <p><i>high cabinet incl. top</i> <i>1 door</i> <i>2 glass shelves</i> <b>handle vertical</b></p>	30	91,2	17,6	<b>HBFT3FL</b> <b>HBFT3FR</b>	Links/ <i>left</i> Rechts/ <i>right</i>		
 <p>Highboard inkl. Abdeckplatte 1 Tür 2 Glaseinlegeböden <b>Griff senkrecht</b></p> <p><i>high cabinet incl. top</i> <i>1 door</i> <i>2 glass shelves</i> <b>handle vertical</b></p>	40	91,2	17,6	<b>HBFT4FL</b> <b>HBFT4FR</b>	Links/ <i>left</i> Rechts/ <i>right</i>		



EEK/EEC=Energieeffizienzklasse/energy efficiency category

Beschreibung Description	Maße in cm Dimensions in cm			Artikel-Nr. Article no.	Türanschlag Door stop	Identnummer ID number
	B/W	H	T/D			
 <p>Mineralmarmor-Waschtisch Ablage rechts inkl. Permanentablauf</p> <p><i>marble minerals washbasin depot on the right incl. permanent flow</i></p>	60,0	14,0	10,5/ 30,1	<b>MWGBB6</b>		
						
 <p>Raumsparsiphon basin siphon</p>				<b>RSPAR-4</b>		
 <p>Einhebel-Waschtischarmatur chrom inkl. Zugstange und Befestigungsmaterial</p> <p><i>single lever top, chrome incl. eccentric tappet and fastening materials</i></p>				<b>MBSU</b>		
						<b>PG2 matt/matt</b>
 <p>Waschtisch-Unterschrank 1 Tür, 1 Regal mit 3 Böden</p> <p><i>washbasin base cabinet 1 door, 1 shelf with 3 boards</i></p>	60,0	47,8	30,0	<b>WMMTR6</b>		
 <p>Spiegelpaneel LED Beleuchtung 10 W, satiniert 4000 Kelvin EEK A-A++</p> <p><i>mirror panel LED-lighting 10 W, satined 4000 Kelvin EEC A-A++</i></p>	45,0	68,2	2,0	<b>SPLEI45</b>		
						
						<b>PG2 matt/matt</b>
 <p>Highboard inkl. Abdeckplatte mit Regal 1 Tür, 1 Glaseinlegeboden Regal mit 3 Glasablagen</p> <p><i>high cabinet incl. top with glass shelf 1 door, 1 glass board shelf with 3 glass boards</i></p>	30,0	95,6	10,5/ 18,6	<b>HBRG3L</b>	Links/ <i>left</i>	
 <p>Highboard inkl. Abdeckplatte mit Regal 1 Tür, 1 Glaseinlegeboden Regal mit 3 Glasablagen</p> <p><i>high cabinet incl. top with glass shelf 1 door, 1 glass board shelf with 3 glass boards</i></p>	30,0	95,6	10,5/ 18,6	<b>HBRG3R</b>	Rechts/ <i>right</i>	
 <p><b>i</b> Regal für seitliche Montage oder frei- hängend, inkl. Aufhänger</p> <p><i>shelf for side mounting or free-hanging incl. hanging brackets</i></p>	15,0	68,2	11,6	<b>REA15</b>		

EEK/EEC=Energieeffizienzklasse/energy efficiency category

**i** Regalfarben unbedingt mit angeben, Übersicht siehe Seite 8. Please indicate shelf colours, overview see page 8.

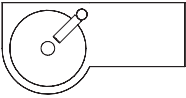
Beschreibung Description	Maße in cm Dimensions in cm			Artikel-Nr. Article no.	Türanschlag Door stop	Identnummer ID number
	B/W	H	T/D			

	Mineralmarmor-Waschtisch Ablage rechts inkl. Permanentablauf  <i>marble minerals washbasin depot on the right incl. permanent flow</i>	60,0	1,2/ 12,4	30,0 20,0	<b>MWGBC6</b>  	
---	---	------	--------------	--------------	--	--

	Designsiphon  <i>design siphon</i>				<b>DS</b>	
---	--	--	--	--	-----------	--

	Einhebel-Waschtischarmatur chrom inkl. Zugstange und Befestigungsmaterial  <i>single lever top, chrome incl. eccentric tappet and fastening materials</i>				<b>MBSU</b>	
---	--	--	--	--	-------------	--

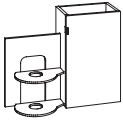

						PG1 Dickkante/thick edge
--	--	--	--	--	--	-----------------------------

	Waschtisch-Unterschrank <b>mit Griff</b> 1 Tür, 1 Glaseinlegeboden  <i>washbasin base cabinet <b>with handle</b> 1 door, 1 glass board</i>	30,0	47,8	20,5	<b>WMMT3</b>	Rechts/ <i>right</i>
---	---	------	------	------	--------------	----------------------

	Waschtisch-Unterschrank <b>mit Griff</b> 1 Tür, 1 Glaseinlegeboden, 1 Waschtischunterschrank-Regal mit 2 Acrylglasböden  <i>washbasin base cabinet <b>with handle</b> 1 door, 1 glass board 1 washbasin base cabinet-shelf with 2 acryl glass boards</i>	60,0	47,8	20,5	<b>WMMGT6</b>	Rechts/ <i>right</i>
---	---	------	------	------	---------------	----------------------

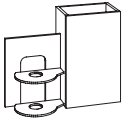
	Waschtisch-Unterschrank <b>push to open</b> 1 Tür, 1 Glaseinlegeboden  <i>washbasin base cabinet <b>push to open</b> 1 door, 1 glass board</i>	30,0	47,8	20,5	<b>WMMT3P</b>	Rechts/ <i>right</i>
---	---	------	------	------	---------------	----------------------

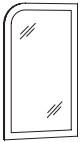
	Waschtisch-Unterschrank <b>push to open</b> 1 Tür, 1 Glaseinlegeboden, 1 Waschtischunterschrank-Regal mit 2 Acrylglasböden  <i>washbasin base cabinet <b>push to open</b> 1 door, 1 glass board 1 washbasin base cabinet-shelf with 2 acryl glass boards</i>	60,0	47,8	20,5	<b>WMMGT6P</b>	Rechts/ <i>right</i>
---	---	------	------	------	----------------	----------------------







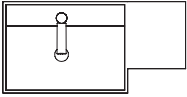

	Spiegelpaneel LED Beleuchtung 19,2 W, satiniert 4000 Kelvin EEK A-A++  <i>mirror panel LED-lighting 19,2 W, satined 4000 Kelvin EEC A-A++</i>	45,0	80,0	2,0	<b>SPLEJ45</b>  	
---	---	------	------	-----	---	--

	Regal für seitliche Montage oder frei- hängend, inkl. Aufhänger  <i>shelf for side mounting or free-hanging incl. hanging brackets</i>	15,0	80,0	11,6	<b>REAM15</b>	
---	---	------	------	------	---------------	--

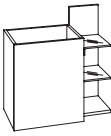
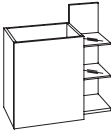
	Regal freihängend inkl. Aufhänger  <i>shelf free-hanging incl. hanging brackets</i>	30,0	47,8	11,6	<b>REAK30</b>	
---	--	------	------	------	---------------	--





EEK/EEC=Energieeffizienzklasse/energy efficiency category

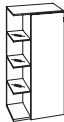

 Regalfarben unbedingt mit angeben, Übersicht siehe Seite 8. Please indicate shelf colours, overview see page 8.

Beschreibung Description	Maße in cm Dimensions in cm			Artikel-Nr. Article no.	Türanschlag Door stop	Identnummer ID number
	B/W	H	T/D			
 <p>Mineralmarmor-Waschtisch Ablage rechts inkl. Permanentablauf</p> <p><i>marble minerals washbasin depot on the right incl. permanent flow</i></p>	60,0	1,2/ 12,4	22,0 30,0	<b>MWGBD6</b>		
 <p>Einhebel-Waschtischarmatur chrom inkl. Zugstange und Befestigungsmaterial</p> <p><i>single lever top, chrome incl. eccentric tappet and fastening materials</i></p>				<b>MBSU</b>		
						PG1 Dickkante/thick edge
 <p>Waschtisch-Unterschrank <b>mit Griff</b> 1 Tür, 1 Regal mit 2 Glasablagen</p> <p><i>washbasin base cabinet <b>with handle</b> 1 door, 1 shelf with 2 glass boards</i></p>	60,0	47,8 59,0	29,5	<b>WMDTR6</b>		
 <p>Waschtisch-Unterschrank <b>push to open</b> 1 Tür, 1 Regal mit 2 Glasablagen</p> <p><i>washbasin base cabinet <b>push to open</b> 1 door, 1 shelf with 2 glass boards</i></p>	60,0	47,8 59,0	29,5	<b>WMDTR6P</b>		
 <p>Spiegelpaneel, Sensorschalter LED Beleuchtung 17,8 W, satiniert 4000 Kelvin EEK A-A++</p> <p><i>mirror panel, sensor switch LED-lighting 17,8 W, satined 4000 Kelvin EEC A-A++</i></p>	40,0	80,0	2,0	<b>SPLEK4</b>	 	
 <p>Highboard inkl. Abdeckplatte <b>mit Griff</b> 1 Tür, 2 Glaseinlegeböden</p> <p><i>Highboard incl. top <b>with handle</b> 1 door, 2 glass boards</i></p>	30,0	90,4	17,6	<b>HBLT3F</b>	Links/ <i>left</i> Rechts/ <i>right</i>	
 <p>Highboard inkl. Abdeckplatte <b>mit Griff</b> 1 Tür, 2 Glaseinlegeböde Regal mit 2 Glasböden oben</p> <p><i>Highboard incl. top <b>with handle</b> 1 door, 2 glass boards shelf with 2 glass boards above</i></p>	30,0	119,0	17,6	<b>HBRT3FL</b> <b>HBRT3FR</b>	Links/ <i>left</i> Rechts/ <i>right</i>	

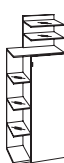
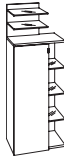
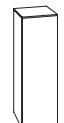
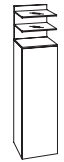
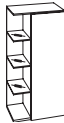
EEK/EEC=Energieeffizienzklasse/energy efficiency category

Beschreibung Description	Maße in cm Dimensions in cm			Artikel-Nr. Article no.	Türanschlag Door stop	Identnummer ID number
	B/W	H	T/D			

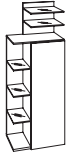
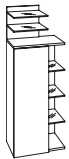
						PG1 Dickkante/thick edge
	Highboard inkl. Abdeckplatte <b>mit Griff</b> 1 Tür rechts, 2 Glaseinlegeböden Regal links mit 3 Glasablagen  <i>Highboard incl. top <b>with handle</b> 1 door right, 2 glass boards shelf left with 3 glass boards</i>	45,0	90,4	17,6	<b>HBRT45FL</b> <b>HBRT45FR</b>	Links/ <i>left</i> Rechts/ <i>right</i>
	Highboard inkl. Abdeckplatte <b>mit Griff</b> 1 Tür links, 2 Glaseinlegeböden Regal rechts mit 3 Glasablagen  <i>Highboard incl. top <b>with handle</b> 1 door left, 2 glass boards shelf right with 3 glass boards</i>	45,0	90,4	17,6	<b>HBRT45FL</b> <b>HBTR45FR</b>	Links/ <i>left</i> Rechts/ <i>right</i>
	Highboard inkl. Abdeckplatte <b>mit Griff</b> 1 Tür rechts, 2 Glaseinlegeböden Regal links mit 3 Glasablagen, Regal mit 2 Glasböden oben  <i>Highboard incl. top <b>with handle</b> 1 door right, 2 glass boards shelf left with 3 glass boards shelf with 2 glass boards above</i>	45,0	119,0	17,6	<b>HBRRT45L</b> <b>HBRRT45R</b>	Links/ <i>left</i> Rechts/ <i>right</i>
	Highboard inkl. Abdeckplatte <b>mit Griff</b> 1 Tür links, 2 Glaseinlegeböden Regal rechts mit 3 Glasablagen, Regal mit 2 Glasböden oben  <i>Highboard incl. top <b>with handle</b> 1 door left, 2 glass boards shelf right with 3 glass boards, shelf with 2 glass boards above</i>	45,0	119,0	17,6	<b>HBRT45L</b> <b>HBTR45R</b>	Links/ <i>left</i> Rechts/ <i>right</i>
	Highboard inkl. Abdeckplatte <b>push to open</b> , 1 Tür, 2 Glaseinlegeböden  <i>Highboard incl. top <b>push to open</b>, 1 door, 2 glass boards</i>	30,0	90,4	17,6	<b>HBLT3PFL</b> <b>HBLT3PFR</b>	Links/ <i>left</i> Rechts/ <i>right</i>
	Highboard inkl. Abdeckplatte <b>push to open</b> , 1 Tür, 2 Glaseinlegeböden Regal mit 2 Glasböden oben  <i>Highboard incl. top <b>push to open</b>, 1 door, 2 glass boards shelf with 2 glass boards above</i>	30,0	119,0	17,6	<b>HBRT3PFL</b> <b>HBRT3PFR</b>	Links/ <i>left</i> Rechts/ <i>right</i>
	Highboard inkl. Abdeckplatte <b>push to open</b> , 1 Tür rechts, 2 Glaseinlegeböden Regal links mit 3 Glasablagen  <i>Highboard incl. top <b>push to open</b> 1 door right, 2 glass boards shelf left with 3 glass boards</i>	45,0	90,4	17,6	<b>HBRT45PFL</b> <b>HBRT45PFR</b>	Links/ <i>left</i> Rechts/ <i>right</i>
	Highboard inkl. Abdeckplatte <b>push to open</b> , 1 Tür links, 2 Glaseinlegeböden Regal rechts mit 3 Glasablagen  <i>Highboard incl. top <b>push to open</b> 1 door left, 2 glass boards shelf right with 3 glass boards</i>	45,0	90,4	17,6	<b>HBTR45PFL</b> <b>HBTR45PFR</b>	Links/ <i>left</i> Rechts/ <i>right</i>

Beschreibung Description	Maße in cm Dimensions in cm			Artikel-Nr. Article no.	Türanschlag Door stop	Identnummer ID number
	B/W	H	T/D			
 <p>Highboard inkl. Abdeckplatte <b>push to open</b>, 1 Tür rechts, 2 Glaseinlegeböden Regal links mit 3 Glasablagen, Regal mit 2 Glasböden oben</p> <p><i>Highboard incl. top <b>push to open</b> 1 door right, 2 glass boards shelf left with 3 glass boards, shelf with 2 glass boards above</i></p>	45,0	119,0	17,6	<b>HBRRT45PL</b> <b>HBRRT45PR</b>	Links/ <i>left</i> Rechts/ <i>right</i>	PG1 Dickkante/ <i>thick edge</i>
 <p>Highboard inkl. Abdeckplatte <b>push to open</b>, 1 Tür links, 2 Glaseinlegeböden Regal rechts mit 3 Glasablagen, Regal mit 2 Glasböden oben</p> <p><i>Highboard incl. top <b>push to open</b> 1 door left, 2 glass boards shelf right with 3 glass boards, shelf with 2 glass boards above</i></p>	45,0	119,0	17,6	<b>HBRT45PL</b> <b>HBRT45PR</b>	Links/ <i>left</i> Rechts/ <i>right</i>	
 <p><b>i</b> Regal freihängend inkl. Aufhänger</p> <p><i>shelf free-hanging incl. Hanging brackets</i></p>	29,6	28,6	15,0	<b>RGB3</b>		

**i** Regalfarben unbedingt mit angeben, Übersicht siehe Seite 8. *Please indicate shelf colours, overview see page 8.*

# 3010 »Maße/dimensions«

Bohrlochhöhen für Schraubhaken, Anschlussmaße und Abflusshöhen/drilling point for screw hooks, dimensions for mounting and drain

## 3010.1

MWGBS5/WMJK5  
GWGBS5

MT2

SPLEA4

\* Raumsparnsiphon [ RSS ]  
im Zubehör erhältlich.  
Basin siphon [ RSS ]  
available in accessories.

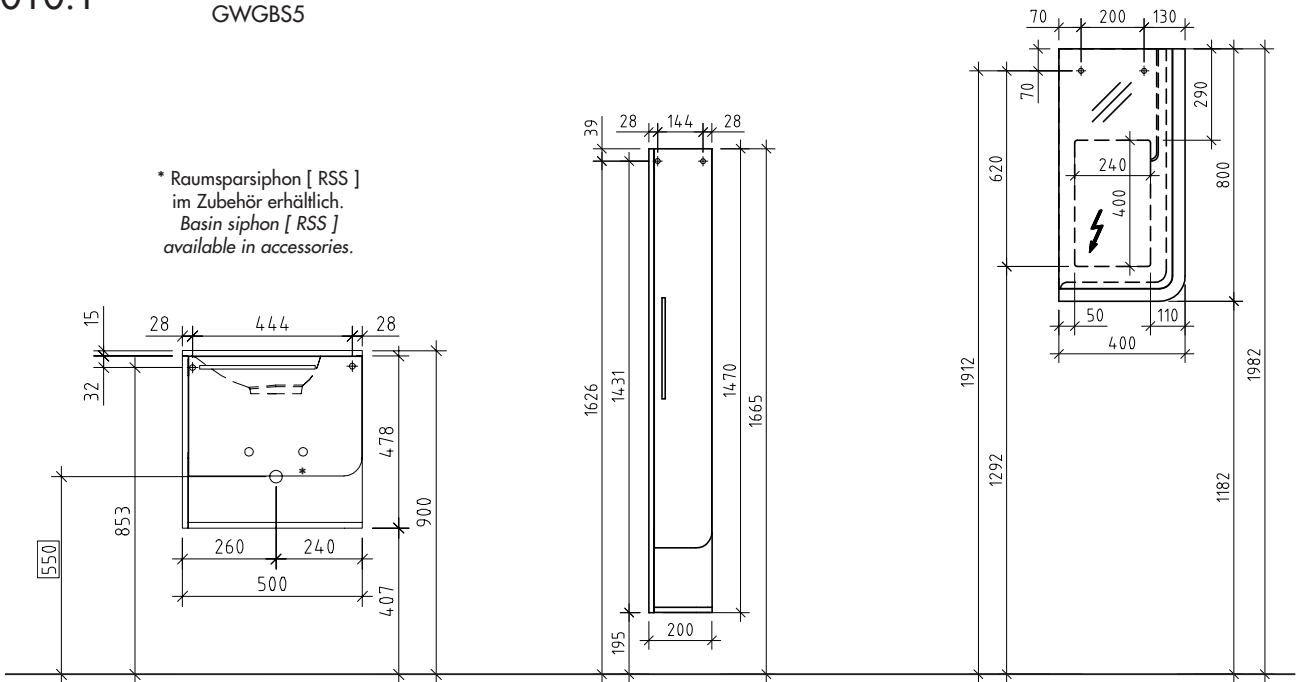

## 3010.2

MWGB06/WMMK6

HBRT3RG/  
HBRT3LG

SPLEB5

\* Raumsparnsiphon [ RSS ]  
im Zubehör erhältlich.  
Basin siphon [ RSS ]  
available in accessories.

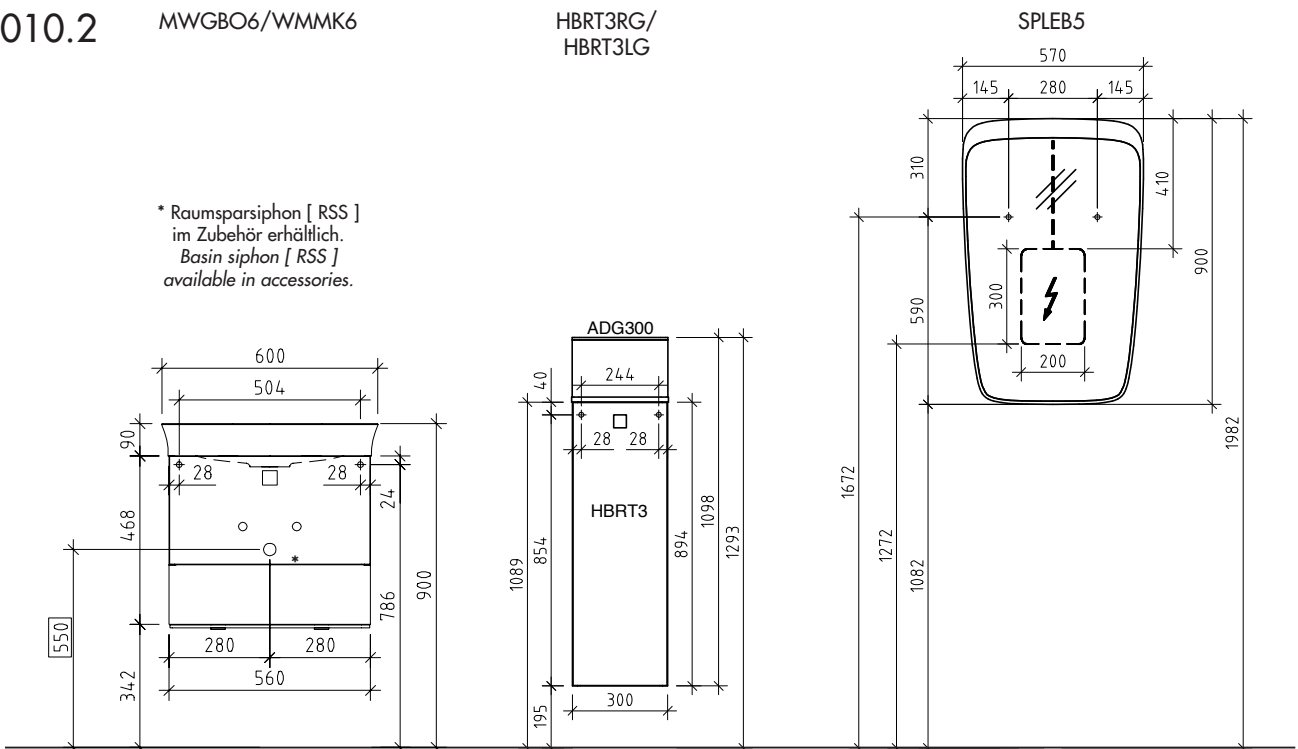

**!** Achtung: Die Montage muss durch fachkundige Personen erfolgen. Der Untergrund zur Wandbefestigung ist vor Montage zu prüfen. Bitte wählen Sie entsprechend das geeignete Befestigungsmaterial. Fehlerhafte Montagen können das Möbel beschädigen oder dessen Funktion dauerhaft beeinträchtigen. Für Sach- und Personenschäden übernehmen wir im Falle einer unsachgemäßen Montage keine Haftung.  
Attention: Assembly must be carried out by skilled personnel. The subsurface for the wall mounting must be checked before assembly. Please select a suitable mounting material. Faulty assembly can damage furniture or permanently impair its function. We will not be held responsible for damage to material or persons in the case of improper assembly.

3010.3

MWGBS7/WMNT7

MRRT4

SPLEC5

\* Raumsparisiphon [ RSPAR-4 ]  
im Zubehör erhältlich.  
Basin siphon [ RSPAR-4 ]  
available in accessories.

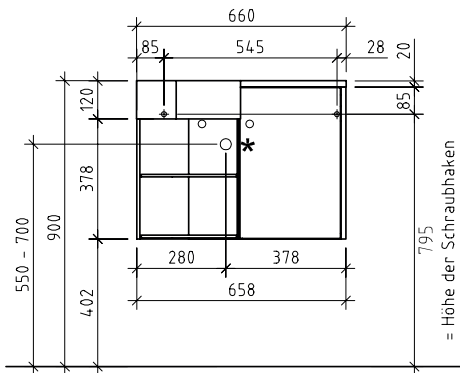

= Höhe der Schraubhaken

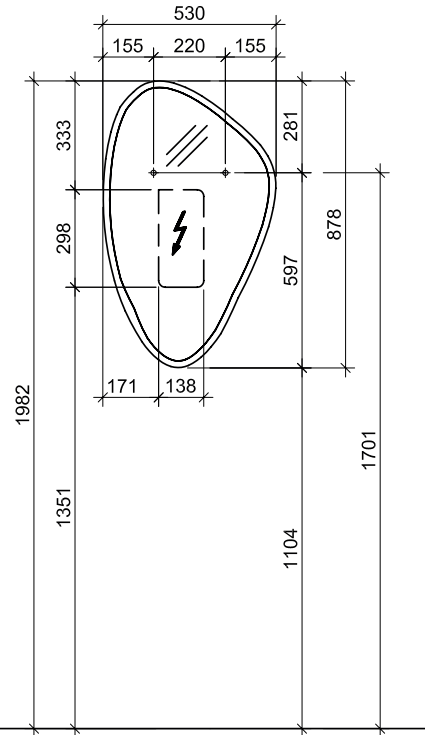
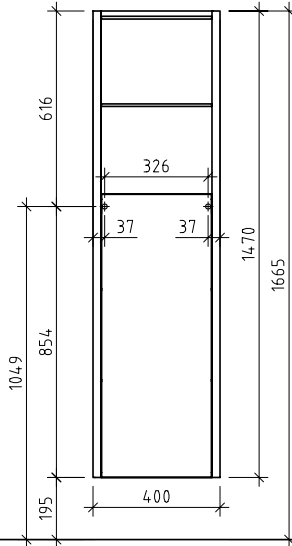

3010.5

MWGBA6/  
WMNT6

HBFT3F/HBFT4F

SPRA6

\* Raumsparisiphon [ RSS ]  
im Zubehör erhältlich.  
Basin siphon [ RSPAR-4 ]  
available in accessories.

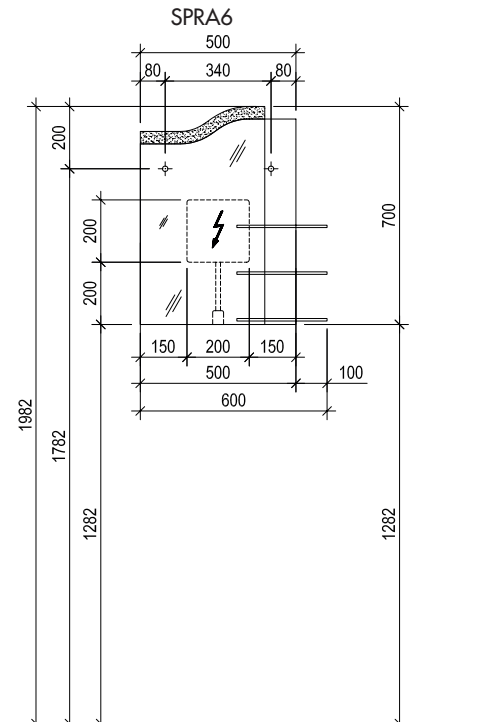
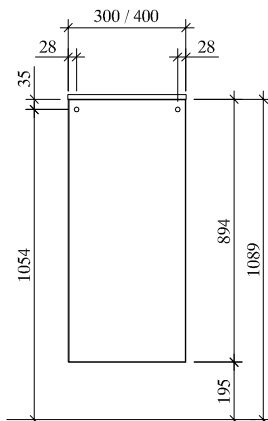
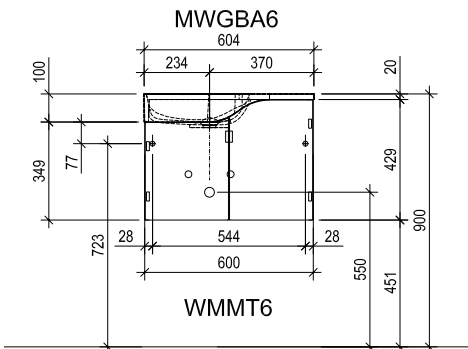

**!** Achtung: Die Montage muss durch fachkundige Personen erfolgen. Der Untergrund zur Wandbefestigung ist vor Montage zu prüfen. Bitte wählen Sie entsprechend das geeignete Befestigungsmaterial. Fehlerhafte Montagen können das Möbel beschädigen oder dessen Funktion dauerhaft beeinträchtigen. Für Sach- und Personenschäden übernehmen wir im Falle einer unsachgemäßen Montage keine Haftung.  
Attention: Assembly must be carried out by skilled personnel. The subsurface for the wall mounting must be checked before assembly. Please select a suitable mounting material. Faulty assembly can damage furniture or permanently impair its function. We will not be held responsible for damage to material or persons in the case of improper assembly.

# 3010 »Maße/dimensions«

Bohrlochhöhen für Schraubhaken, Anschlussmaße und Abflusshöhen/drilling point for screw hooks, dimensions for mounting and drain

## 3010.6

GWGB05/  
WGA5

HBFT3F/HBFT4F

SPLC5

\* Raumsiphon [ RSS ]  
im Zubehör erhältlich.  
Basin siphon [ RSS ]  
available in accessories.

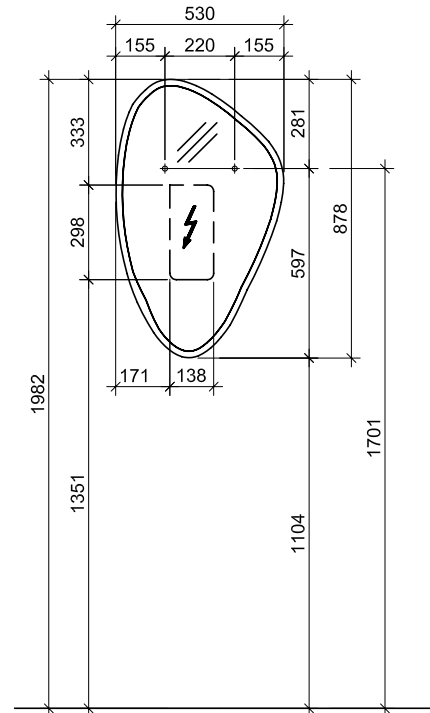
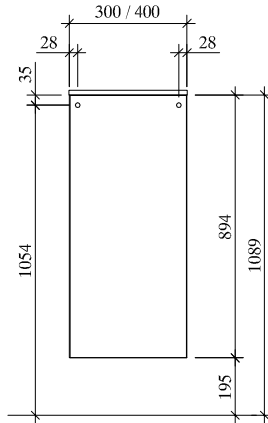
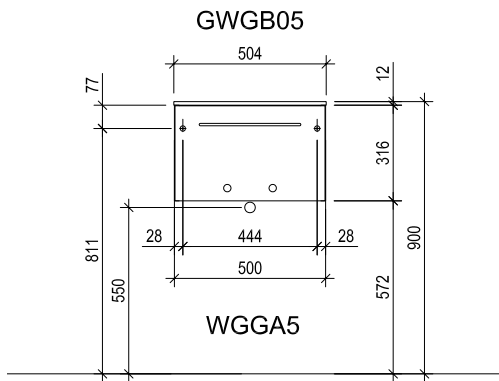

## 3010.7

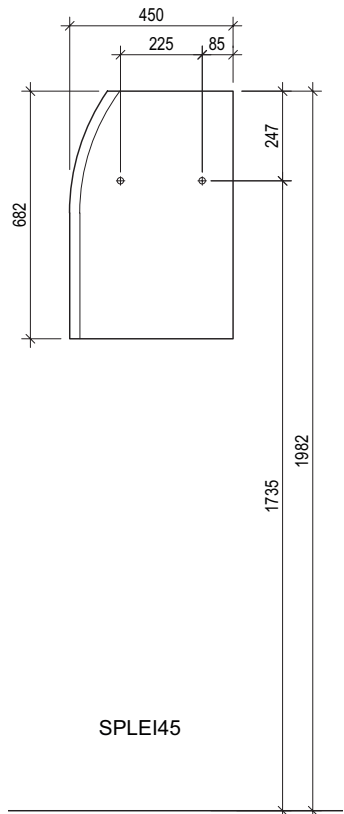
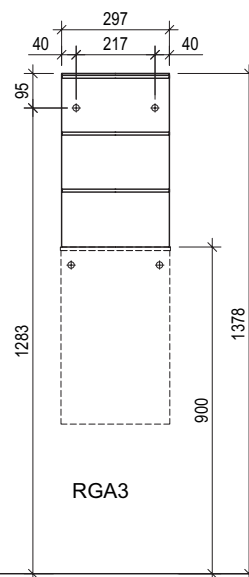
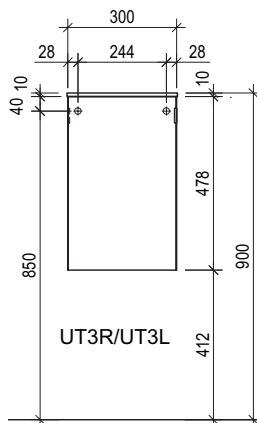
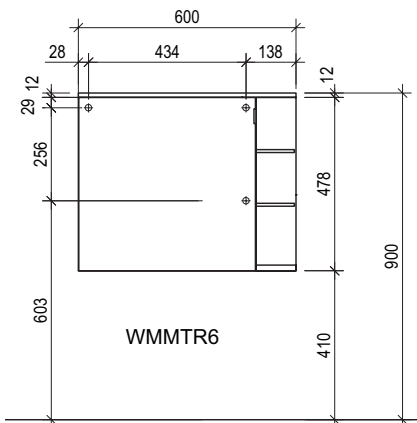

**!** Achtung: Die Montage muss durch fachkundige Personen erfolgen. Der Untergrund zur Wandbefestigung ist vor Montage zu prüfen. Bitte wählen Sie entsprechend das geeignete Befestigungsmaterial. Fehlerhafte Montagen können das Möbel beschädigen oder dessen Funktion dauerhaft beeinträchtigen. Für Sach- und Personenschäden übernehmen wir im Falle einer unsachgemäßen Montage keine Haftung.  
Attention: Assembly must be carried out by skilled personnel. The subsurface for the wall mounting must be checked before assembly. Please select a suitable mounting material. Faulty assembly can damage furniture or permanently impair its function. We will not be held responsible for damage to material or persons in the case of improper assembly.

# »3010« Maße/dimensions

Bohrlochhöhen für Schraubhaken, Anschlussmaße und Abflusshöhen/drilling point for screw hooks, dimensions for mounting and drain

## 3010.8

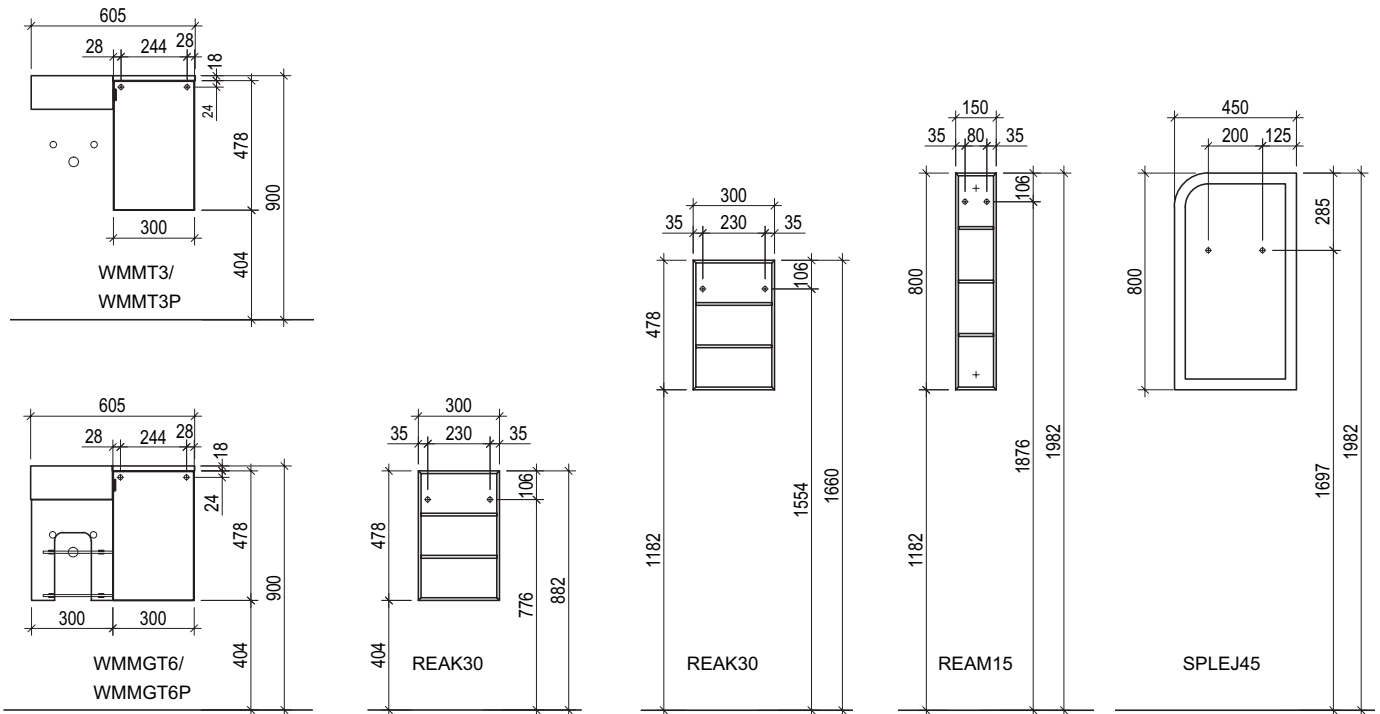

## 3010.9

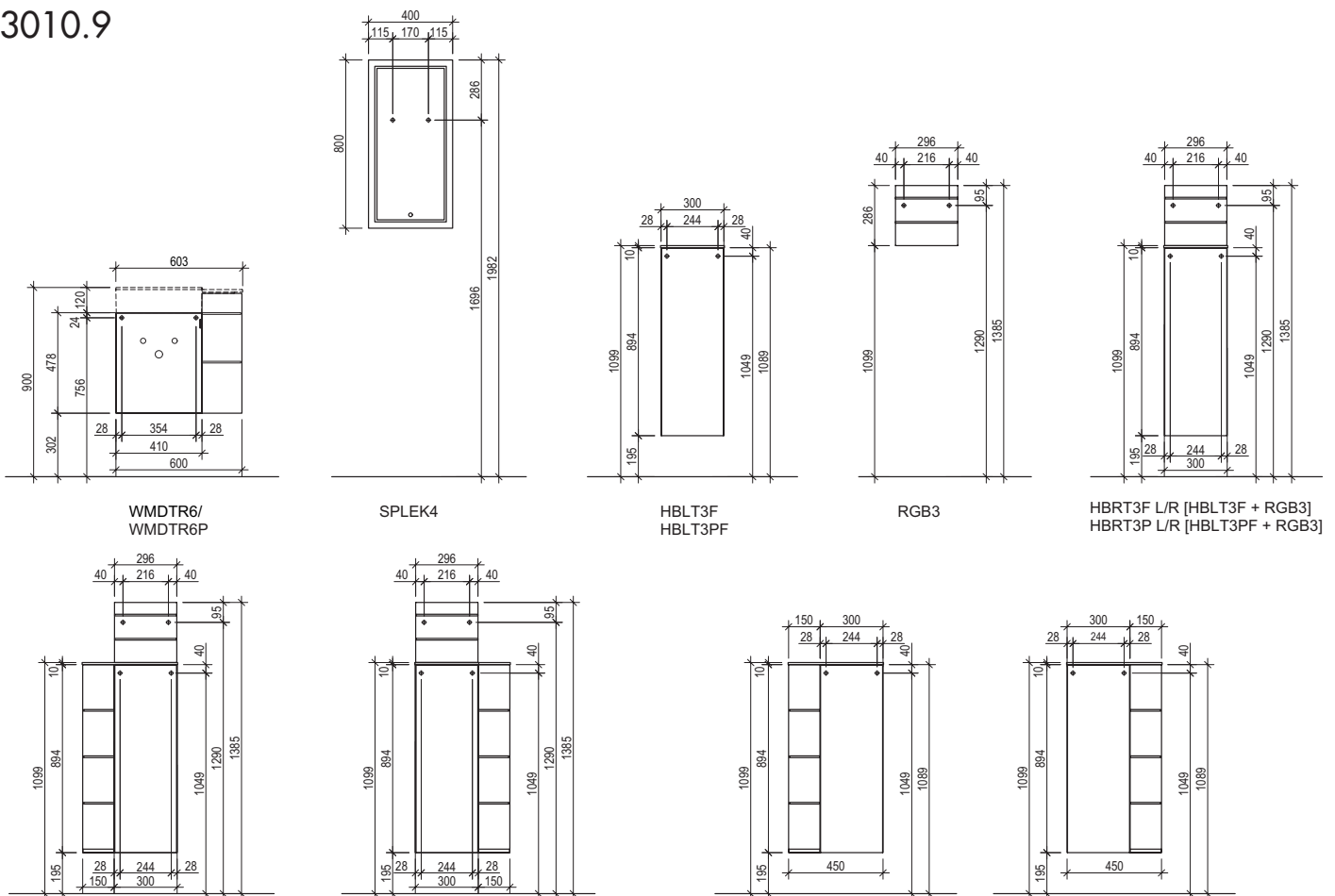

Achtung: Die Montage muss durch fachkundige Personen erfolgen. Der Untergrund zur Wandbefestigung ist vor Montage zu prüfen. Bitte wählen Sie entsprechend das geeignete Befestigungsmaterial. Fehlerhafte Montagen können das Möbel beschädigen oder dessen Funktion dauerhaft beeinträchtigen. Für Sach- und Personenschäden übernehmen wir im Falle einer unsachgemäßen Montage keine Haftung.

Attention: Assembly must be carried out by skilled personnel. The subsurface for the wall mounting must be checked before assembly. Please select a suitable mounting material. Faulty assembly can damage furniture or permanently impair its function. We will not be held responsible for damage to material or persons in the case of improper assembly.