

Möbel LETZ

Finden und Wohlfühlen



Typenplan

3020 von Marlin - Waschtisch-Set in Anthrazit

Wichtiger Hinweis für Sie

Etwaige Hinweise des Herstellers in dieser Produktinformation, die sich auf die Gewährleistung beziehen, haben für Sie keinerlei Bindungswirkung und können von Ihnen ignoriert werden. Ihre gesetzlichen Gewährleistungsrechte als Verbraucher uns gegenüber, als Ihrem Verkäufer, werden dadurch in keiner Weise berührt oder eingeschränkt. Sie können sich wegen aller Mängel jederzeit an uns wenden. Darüber hinaus gehende Herstellergarantien bleiben

Schlangen, Deutschland

Möbel Letz GmbH
Am Gewerbepark 11
06895 Zahna-Elster

Tel.: 035383 - 6018 50

Fax.: 035383 - 6018 17

MARLIN BAD 3020



Piktogramme/pictograms



Mineralmarmor Waschtisch
Marble minerals washbasin



LED Lichtfarbe kalt
LED colour temperature cold



LED mit Bewegungssensor
LED with motion sensor



Keramik Waschtisch
Ceramic washbasin



LED Lichtfarbe warm
LED colour temperature warm



LED mit Sensorschalter
LED with sensor switch



Glas Waschtisch
Glass washbasin



LED Lichtfarbe regelbar,
Helligkeit dimmbar
LED colour temperature adjust-
able, brightness dimmable



LED Lichtfarbe schaltbar bzw. regelbar
LED colour temperature adjustable

Mineralmarmor Waschtisch weiß alpin Glanz (LF69) Marble minerals washbasin gloss alpine white (LF69)

≈ Beckenmaße in cm (BxHxT)
basin dimensions in cm (WxHxD)

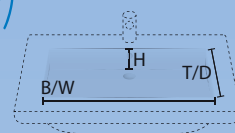

FMW80 | 55 x 12 x 30 cm

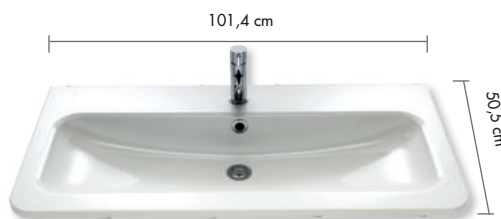

FMW100 | 75 x 12 x 30 cm



Detail

Mineralmarmor Waschtisch weiß alpin Glanz (Loft) Marble minerals washbasin gloss alpine white (Loft)



Mwide8 | 68 x 12 x 30 cm



Mwide10 | 68 x 12 x 30 cm

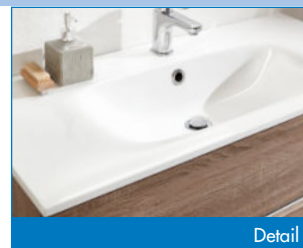

Detail

Mineralmarmor Glanz/gloss marble minerals (Loft)

PG1



Weiß Alpin Glanz
Gloss Alpine White
LF69

Bei granitfarbigen Waschtischen kann es zu Farbabweichungen kommen, da der Gelcoat die Farbgebung maßgeblich beeinflusst und sich im Laufe der Zeit die Farbe durch Lichteinflüsse (Sonneneinstrahlung) verändern kann.
Because the gelcoat influences the shade by effect of light (shafts of sunlight) the granit-coloured washbasins can vary in colour.

PG2



Granit Weiß Glimmer
White Granite Glimmer
LF74



Granit Grau Glimmer
Grey Granite Glimmer
LF73

Keramik Waschtisch weiß alpin Glanz (LFK) Ceramic washbasin gloss alpine white (LFK)

 ≈ Beckenmaße in cm (BxHxT)
basin dimensions in cm (WxHxD)

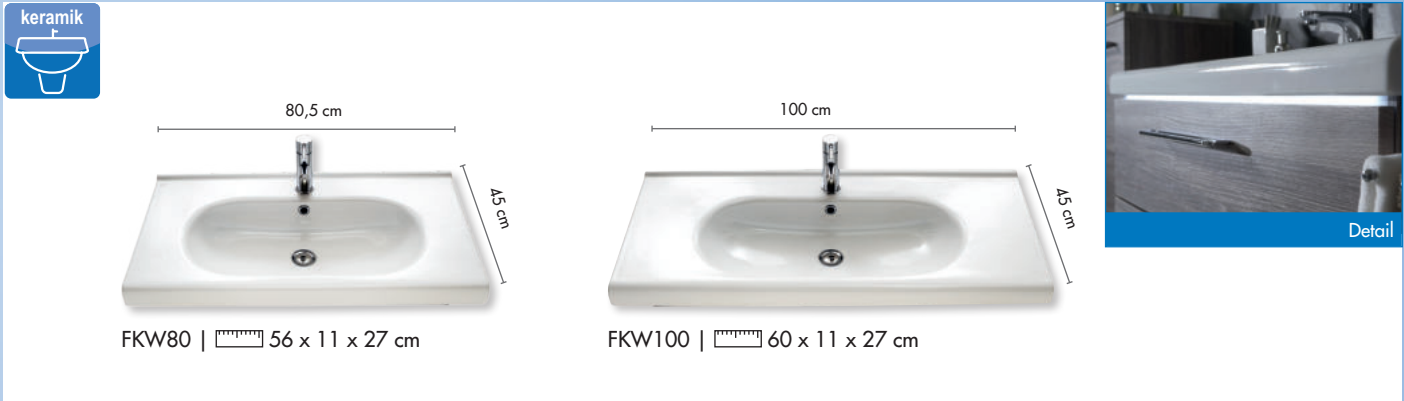
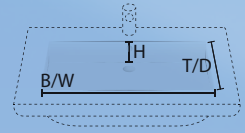

Befestigungsmaterial für Keramikwaschtisch MONK-4 MONK-4 fastening material for ceramic washbasin

Wir empfehlen eine Montage nur durch einen qualifizierten Monteur/Installateur. Keine Haftung bei unsachgemäßer Montage. Das Befestigungsmaterial für Standard-Keramikwaschtisch ist inklusive (2 Stockschrauben M10x120 inkl. Dübel für massive Steinwand. Bei anderen Wandbeschaffenheiten muss der Dübel entsprechend angepasst werden).

We recommend installation only by a qualified fitter / installer. No liability for improper installation. The mounting material for the standard ceramic washbasin is included (2 screws M10x120 including dowels for solid stone wall, for other wall conditions the dowel must be adapted accordingly).

Keramik Waschtisch weiß alpin Glanz (Elite) Ceramic washbasin gloss alpine white (elite)

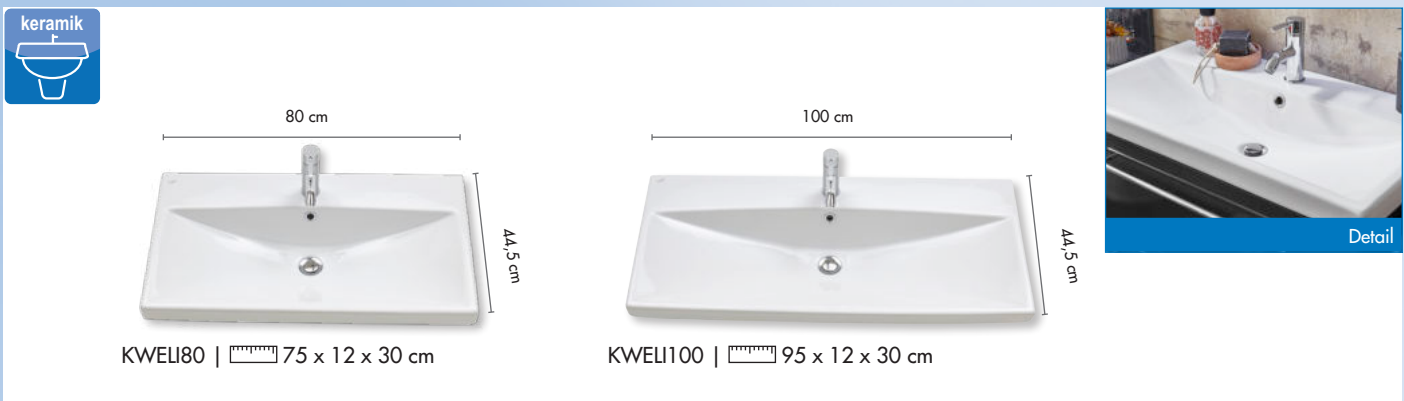

Befestigungsmaterial für Keramikwaschtisch MONK-4 MONK-4 fastening material for ceramic washbasin

Wir empfehlen eine Montage nur durch einen qualifizierten Monteur/Installateur. Keine Haftung bei unsachgemäßer Montage. Das Befestigungsmaterial für Standard-Keramikwaschtisch ist inklusive (2 Stockschrauben M10x120 inkl. Dübel für massive Steinwand. Bei anderen Wandbeschaffenheiten muss der Dübel entsprechend angepasst werden).

We recommend installation only by a qualified fitter / installer. No liability for improper installation. The mounting material for the standard ceramic washbasin is included (2 screws M10x120 including dowels for solid stone wall, for other wall conditions the dowel must be adapted accordingly).

Schränke/cabinets 3020

Frontfarben/front colours

Dickkante/thick edge

286



Weiß Seidenglanz
Silk Gloss White
LFM_

464



Kastanie Trüffel Nachbildung
Truffle Chestnut Finish
LFR_

284



Anthrazit Seidenglanz
Silk Gloss Anthracite
LFA_

473



Eiche Struktur Nachbildung
Oak Structure Finish
LFX_

MDF-foliert/MDF-coated

449



Kastanie Graphit Nachbildung
Graphite Chestnut Finish
LFC_

961



Weiß Glanz
Gloss White
LFG_

438



Anthrazit Glanz
Gloss Anthracite
LFF_

Korpusfarben/basic shell colours

PG 1

286



Weiß Seidenglanz
Silk Gloss White
E/LF86

464



Kastanie Trüffel Nachbildung
Truffle Chestnut Finish
Z/LF64

284



Anthrazit Seidenglanz
Silk Gloss Anthracite
A/LF84

473



Eiche Struktur Nachbildung
Oak Structure Finish
M/LF55

PG 2

490



Kastanie Graphit Nachbildung
Graphite Chestnut Finish
C/LF45

PG 3

042



Weiß Glanz Folie
Gloss White
G/LF50

438



Anthrazit Glanz Folie
Gloss Anthracite
F/LF30

! BITTE BEACHTEN:

Die Front-/Korpuskombination „MDF-folierte Front (Variante: 449/961/438)“ mit „Korpus PG1 (Variante: 284/286/464/473)“ wird zu PG2 abgerechnet.
The front / basic shell combination „MDF-foiled front (variant: 449/961/438)“ with „basic shell PG1 (variant: 284/286/464/473)“ is billed to PG2.

Griffe/handles



Chrom Glanz
Gloss Chrome
193/187
⌀-⌀ 96 mm/460 mm



Chrom Glanz
Gloss Chrome
321/322
⌀-⌀ 128 mm/256 mm

⌀-⌀ = Bohrabstand/hole spacing

Beleuchtung / lighting

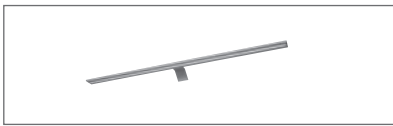

Aufbauleuchte LED
Top light LED



Oberboden mit 2 LED Streifen
Top with 2 LED stripes

Lichtfarbe Tageslicht (Kalt)
Luminous colour natural light (cold)

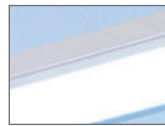







LL54, LL74,
LL94

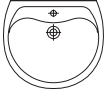

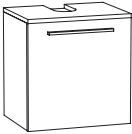

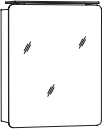







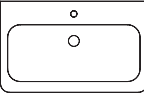

Die Steckdose / Powerbox ist auch in Ausführung für die Schweiz / Frankreich erhältlich. Bitte Mehrpreis beachten (siehe Zubehör Seite 1).
The power socket is also available for Switzerland / France. Please note extra charge (see accessories page 1).

3020 »60 cm Keramik/ceramic«

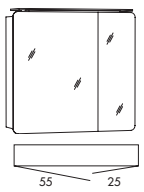
Beschreibung Description	Maße in cm Dimensions in cm			Artikel-Nr. Article no.	Türanschlag Door stop	Identnummer ID number		
	B/W	H	T/D			PG1 Dickkante/ thick edge	PG2 Matt/matt	PG3 Glanz/gloss
 <p>Keramik-Waschtisch inkl. Überlauf</p> <p><i>ceramic washbasin incl. overflow</i></p>	60	23	49,5	KW6		346		
								
 <p>Waschtisch-Unterschrank 1 Tür für kundeneigenen Keramik- Waschtisch</p> <p><i>washbasinbase cabinet 1 door for customers own ceramic washbasin</i></p>	48	49,6	37	FWUE48L FWUE48R	Links/left Rechts/right	333	358	435
 <p>Sockelstellfuß Chrom je 4 Stck / Pack</p> <p><i>Adjustable feet, chromated 4 pcs / unit</i></p>		12/14		SF12C			65	
 <p>Spiegelschrank, 1 Spiegeltür 2 Glaseinlegeböden, LED Aufbauleuchte LL54 5,1 W 6000 Kelvin inkl. Schalter/Steckdose EEK A-A++</p> <p><i>mirror cabinet, 1 mirror door 2 glass shelves, LED lighting LL54 5,1 W 6000 K, incl. switch/socket EEC A-A++</i></p>	60	74,2	17,6	FSPSR60	L=Links/left R=Rechts/right		979	
								

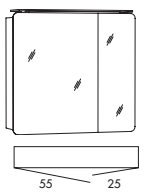







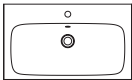

EEK/EEC=Energieeffizienzklasse/energy efficiency category

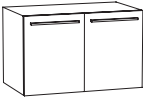
3020 »80 cm Mineralmarmor/marble minerals«

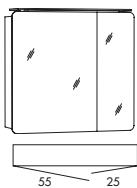
Beschreibung Description	Maße in cm Dimensions in cm			Artikel-Nr. Article no.	Türanschlag Door stop	Identnummer ID number						
	B/W	H	T/D									
 <p>Mineralmarmor-Waschtisch inkl. Überlauf</p> <p><i>marble minerals washbasin incl. overflow</i></p>	81,4	4	50,5	FMW80		710						
 <p>LED-Leiste für Mineralmarmor- Waschtisch inkl. Bewegungssensor 6000 Kelvin, EEK A-A++</p> <p><i>LED band for marble minerals washbasin incl. motion sensor 6000 Kelvin, EEC A-A++</i></p>				LED80M	 	252						
						<table border="1"> <thead> <tr> <th>PG1 Dickkante/ thick edge</th> <th>PG2 Matt/matt</th> <th>PG3 Glanz/gloss</th> </tr> </thead> <tbody> <tr> <td>484</td> <td>538</td> <td>633</td> </tr> </tbody> </table>	PG1 Dickkante/ thick edge	PG2 Matt/matt	PG3 Glanz/gloss	484	538	633
PG1 Dickkante/ thick edge	PG2 Matt/matt	PG3 Glanz/gloss										
484	538	633										
 <p>Waschtisch-Unterschrank 2 Türen</p> <p><i>washbasin base cabinet 2 doors</i></p>	76	47,8	48	FWUMT76								
 <p>Waschtisch-Unterschrank 2 Auszüge</p> <p><i>washbasin base cabinet 2 extensions</i></p>	76	47,8	48	FWUM76								
 <p>Spiegelschrank, 2 Spiegeltüren 2 Glaseinlegeböden, LED Aufbauleuchte LL74 7,0 W 6000 Kelvin, inkl. Schalter/Steckdose EEK A-A++</p> <p><i>mirror cabinet, 2 mirror doors 2 glass shelves, LED lighting LL74 7,0 W 6000 Kelvin, incl. switch/socket EEC A-A++</i></p>	80	68,2/ 74,2	17,6	FSPSR80		1040						
 <p>Spiegelschrank, 2 Spiegeltüren (Innenspiegel) 2 Glaseinlegeböden, LED Aufbauleuchte LL74 7,0 W 6000 Kelvin inkl. Schalter/Steckdose EEK A-A++</p> <p><i>mirror cabinet, 2 mirror doors (inside mirror) 2 glass shelves, LED lighting LL74 7,0 W 6000 Kelvin incl. switch/socket EEC A-A++</i></p>	80	68,2/ 74,2	17,6	FSPSR80S		1079						
 <p>Spiegelpanel Oberboden mit 2 LED-Streifen à 5,8 W 6000 Kelvin, inkl. Schalter mittig unten, EEK A-A++</p> <p><i>mirror panel top with 2 LED stripes each 5,8 W 6000 Kelvin, incl. switch center below, EEC A-A++</i></p>	80	68,2/ 70,1	3/ 10	FSP80		703						

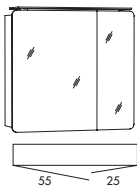

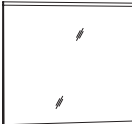







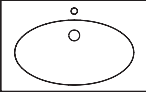

EEK/EEC=Energieeffizienzklasse/energy efficiency category

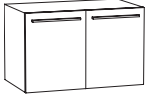
3020 »80 cm Mineralmarmor Loft/*marble minerals Loft*«

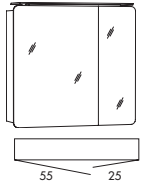
Beschreibung Description	Maße in cm Dimensions in cm			Artikel-Nr. Article no.	Türanschlag Door stop	Identnummer ID number			
	B/W	H	T/D			PG1 Weiß Alpin/ <i>gloss white</i>	PG2 Granit/ <i>granite</i>		
 <p>Mineralmarmor-Waschtisch inkl. Überlauf <i>marble minerals washbasin incl. overflow</i></p>	76,5	1,5	45	MWIDE8			PG1 Weiß Alpin/ <i>gloss white</i> 1011	PG2 Granit/ <i>granite</i> 1264	
									
							PG1 Dickkante/ <i>thick edge</i>	PG2 Matt/ <i>matt</i>	PG3 Glanz/ <i>gloss</i>
 <p>Waschtisch-Unterschrank 2 Türen <i>washbasin base cabinet 2 doors</i></p>	76	47,8	44,5	FWUIT76		768	825	922	
 <p>Waschtisch-Unterschrank 2 Auszüge <i>washbasin base cabinet 2 extensions</i></p>	76	47,8	44,5	FWUI76		927	1004	1142	
 <p>Spiegelschrank, 2 Spiegeltüren 2 Glaseinlegeböden, LED Aufbauleuchte LL74 7,0 W 6000 Kelvin, inkl. Schalter/Steckdose EEK A-A++ <i>mirror cabinet, 2 mirror doors 2 glass shelves, LED lighting LL74 7,0 W 6000 K, incl. switch/socket EEC A-A++</i></p>	80	68,2/ 74,2	17,6	FSPSR80				1040	
 <p>Spiegelschrank, 2 Spiegeltüren (Innenspiegel) 2 Glaseinlegeböden, LED Aufbauleuchte LL74 7,0 W 6000 Kelvin inkl. Schalter/Steckdose EEK A-A++ <i>mirror cabinet, 2 mirror doors (inside mirror) 2 glass shelves, LED lighting LL74 7,0 W 6000 Kelvin incl. switch/socket EEC A-A++</i></p>	80	68,2/ 74,2	17,6	FSPSR80S				1079	
 <p>Spiegelpaneel Oberboden mit 2 LED-Streifen á 5,8 W 6000 Kelvin, inkl. Schalter mittig unten, EEK A-A++ <i>mirror panel top with 2 LED stripes each 5,8 W 6000 Kelvin, incl. switch center below, EEC A-A++</i></p>	80	68,2/ 70,1	3/ 10	FSP80				703	

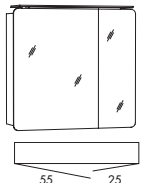
EEK/EEC=Energieeffizienzklasse/energy efficiency category



3020 »80 cm Keramik/ceramic«



Beschreibung Description	Maße in cm Dimensions in cm			Artikel-Nr. Article no.	Türanschlag Door stop	Identnummer ID number						
	B/W	H	T/D									
 <p>Keramik-Waschtisch inkl. Überlauf und Befestigungsmaterial</p> <p><i>ceramic washbasin incl. overflow and fastener</i></p>	80,5	6,5	45	FKW80		710						
 <p>LED-Leiste für Keramik- Waschtisch inkl. Bewegungssensor 6000 Kelvin EEK A-A++</p> <p><i>LED band for ceramic washbasin incl. motion sensor 6000 Kelvin EEC A-A++</i></p>				LED76K	 	176						
						<table border="1"> <thead> <tr> <th>PG1 Dickkante/ thick edge</th> <th>PG2 Matt/matt</th> <th>PG3 Glanz/gloss</th> </tr> </thead> <tbody> <tr> <td>484</td> <td>538</td> <td>633</td> </tr> </tbody> </table>	PG1 Dickkante/ thick edge	PG2 Matt/matt	PG3 Glanz/gloss	484	538	633
PG1 Dickkante/ thick edge	PG2 Matt/matt	PG3 Glanz/gloss										
484	538	633										
 <p>Waschtisch-Unterschrank 2 Türen</p> <p><i>washbasin base cabinet 2 doors</i></p>	76	49,5	44	FWUKT76								
 <p>Waschtisch-Unterschrank 2 Auszüge</p> <p><i>washbasin base cabinet 2 extensions</i></p>	76	49,5	44	FWUK76								
 <p>Spiegelschrank, 2 Spiegeltüren 2 Glaseinlegeböden, LED Aufbauleuchte LL74 7,0 W, 6000 Kelvin inkl. Schalter/Steckdose EEK A-A++</p> <p><i>mirror cabinet, 2 mirror doors 2 glass shelves, LED lighting LL74 7,0 W 6000 K, incl. switch/socket EEC A-A++</i></p>	80	68,2/ 74,2	17,6	FSPSR80		1040						
 <p>Spiegelschrank, 2 Spiegeltüren (Innenspiegel) 2 Glaseinlegeböden, LED Aufbauleuchte LL74 7,0 W 6000 Kelvin inkl. Schalter/Steckdose EEK A-A++</p> <p><i>mirror cabinet, 2 mirror doors (inside mirror), 2 glass shelves, LED lighting LL74 7,0 W, 6000 Kelvin incl. switch/socket EEC A-A++</i></p>	80	68,2/ 74,2	17,6	FSPSR80S		1079						
 <p>Spiegelpaneel Oberboden mit 2 LED-Streifen á 5,8 W 6000 Kelvin inkl. Schalter mittig unten, EEK A-A++</p> <p><i>mirror panel top with 2 LED stripes each 5,8 W 6000 Kelvin, incl. switch center below EEC A-A++</i></p>	80	68,2/ 70,1	3/ 10	FSP80		703						

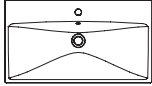

EEK/EEC=Energieeffizienzklasse/energy efficiency category



3020 »80 cm Keramik Elite/ceramic Elite«

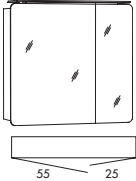

Beschreibung Description	Maße in cm Dimensions in cm			Artikel-Nr. Article no.	Türanschlag Door stop	Identnummer ID number
	B/W	H	T/D			

 <p>Keramik-Waschtisch inkl. Überlauf und Befestigungsmaterial</p> <p><i>ceramic washbasin incl. overflow and fastener</i></p>	80	5	44,5	KWELI80		710

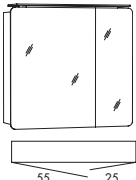
						PG1 Dickkante/ thick edge	PG2 Matt/matt	PG3 Glanz/gloss
 <p>Waschtisch-Unterschrank 2 Türen</p> <p><i>washbasin base cabinet 2 doors</i></p>	76	49,5	44	FWUKT76		484	538	633
 <p>Waschtisch-Unterschrank 2 Auszüge</p> <p><i>washbasin base cabinet 2 extensions</i></p>	76	49,5	44	FWUK76		645	720	847



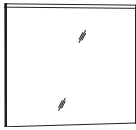



 <p>Spiegelschrank, 2 Spiegeltüren 2 Glaseinlegeböden, LED Aufbauleuchte LL74 7,0 W 6000 Kelvin inkl. Schalter/Steckdose EEK A-A++</p> <p><i>mirror cabinet, 2 mirror doors 2 glass shelves, LED lighting LL74 7,0 W 6000 K, incl. switch/socket EEC A-A++</i></p>	80	68,2/ 74,2	17,6	FSPSR80		1040

 <p>Spiegelschrank, 2 Spiegeltüren (Innenspiegel) 2 Glaseinlegeböden, LED Aufbauleuchte LL74 7,0 W 6000 Kelvin inkl. Schalter/Steckdose EEK A-A++</p> <p><i>mirror cabinet, 2 mirror doors (inside mirror), 2 glass shelves, LED lighting LL74 7,0 W 6000 Kelvin incl. switch/socket EEC A-A++</i></p>	80	68,2/ 74,2	17,6	FSPSR80S		1079

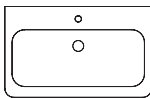
 <p>Spiegelpaneel Oberboden mit 2 LED-Streifen á 5,8 W 6000 Kelvin inkl. Schalter mittig unten EEK A-A++</p> <p><i>mirror panel top with 2 LED stripes each 5,8 W 6000 Kelvin, incl. switch center below EEC A-A++</i></p>	80	68,2/ 70,1	3/ 10	FSP80		703







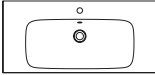

EEK/EEC=Energieeffizienzklasse/energy efficiency category

3020 »100 cm Mineralmarmor/*marble minerals*«

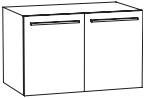
Beschreibung <i>Description</i>	Maße in cm <i>Dimensions in cm</i>			Artikel-Nr. <i>Article no.</i>	Türanschlag <i>Door stop</i>	Identnummer <i>ID number</i>			
	B/W	H	T/D						
 <p>Mineralmarmor-Waschtisch inkl. Überlauf</p> <p><i>marble minerals washbasin incl. overflow</i></p>	101,4	4	50,5	FMW100		798			
 <p>LED-Leiste für Mineralmarmor- Waschtisch inkl. Bewegungssensor 6000 Kelvin, EEK A-A++</p> <p><i>LED band for marble minerals washbasin incl. motion sensor 6000 Kelvin, EEC A-A++</i></p>				LED100M		281			
							PG1 Dickkante/ <i>thick edge</i>	PG2 Matt/ <i>mat</i>	PG3 Glanz/ <i>gloss</i>
 <p>Waschtisch-Unterschrank 2 Türen</p> <p><i>washbasin base cabinet 2 doors</i></p>	96	47,8	48	FWUMT96		505	561	660	
 <p>Waschtisch-Unterschrank 2 Auszüge</p> <p><i>washbasin base cabinet 2 extensions</i></p>	96	47,8	48	FWUM96		711	790	930	
 <p>Spiegelschrank, 3 Spiegeltüren 6 Glaseinlegeböden, LED Aufbauleuchte LL94 8,9 W 6000 Kelvin inkl. Schalter/Steckdose EEK A-A++</p> <p><i>mirror cabinet, 3 mirror doors 6 glass shelves, LED lighting LL94 8,9 W 6000 K, incl. switch/socket EEC A-A++</i></p>	100	68,2/ 74,2	17,6	FSPSR100		1392			
 <p>Spiegelpaneel Oberboden mit 2 LED-Streifen á 7,7 W 6000 Kelvin, inkl. Schalter mittig unten, EEK A-A++</p> <p><i>mirror panel top with 2 LED stripes each 7,7 W 6000 Kelvin, incl. switch center below EEC A-A++</i></p>	100	68,2/ 70,1	3/ 10	FSP100		793			

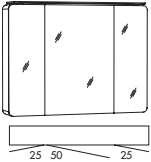

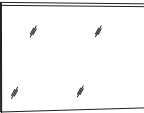





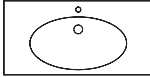

EEK/EEC=Energieeffizienzklasse/energy efficiency category

3020 »100 cm Mineralmarmor Loft/*marble minerals Loft*«

Beschreibung <i>Description</i>	Maße in cm <i>Dimensions in cm</i>			Artikel-Nr. <i>Article no.</i>	Türanschlag <i>Door stop</i>	Identnummer <i>ID number</i>		
	B/W	H	T/D			PG1 <i>Wei Alpin/gloss white</i>	PG2 <i>Granit/granite</i>	
 <p>Mineralmarmor-Waschtisch inkl. Überlauf <i>marble minerals washbasin incl. overflow</i></p>	96,5	1,5	45	MWIDE10		PG1 1159	PG2 1449	
								
						PG1 Dickkante/ <i>thick edge</i>	PG2 Matt/ <i>matt</i>	PG3 Glanz/ <i>gloss</i>
 <p>Waschtisch-Unterschrank 2 Türen <i>washbasin base cabinet 2 doors</i></p>	96	47,8	44,5	FWUIT96		850	907	1004
 <p>Waschtisch-Unterschrank 2 Auszüge <i>washbasin base cabinet 2 extensions</i></p>	96	47,8	44,5	FWUI96		1055	1137	1275
 <p>Spiegelschrank, 3 Spiegeltüren 6 Glaseinlegeböden, LED Aufbauleuchte LL94 8,9 W, 6000 Kelvin inkl. Schalter/Steckdose EEK A-A++ <i>mirror cabinet, 3 mirror doors 6 glass shelves, LED lighting LL94 8,9 W 6000 K, incl. switch/socket EEC A-A++</i></p>	100	68,2/ 74,2	17,6/ 74,2	FSPSR100				1392
 <p>Spiegelpaneel Oberboden mit 2 LED-Streifen á 7,7 W 6000 Kelvin, inkl. Schalter mittig unten EEK A-A++ <i>mirror panel top with 2 LED stripes each 7,7 W 6000 Kelvin, incl. switch center below EEC A-A++</i></p>	100	68,2/ 70,1	3/ 10	FSP100				793

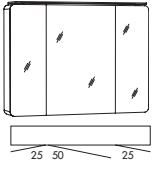

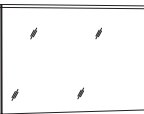
EEK/EEC=Energieeffizienzklasse/energy efficiency category



3020 »100 cm Keramik/ceramic«

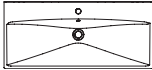

Beschreibung Description	Maße in cm Dimensions in cm			Artikel-Nr. Article no.	Türanschlag Door stop	Identnummer ID number						
	B/W	H	T/D									
 <p>Keramik-Waschtisch inkl. Überlauf und Befestigungsmaterial</p> <p><i>ceramic washbasin incl. overflow and fastener</i></p>	100	6,5	45	FKW100		798						
 <p>LED-Leiste für Keramik- Waschtisch inkl. Bewegungssensor 6000 Kelvin EEK A-A++</p> <p><i>LED band for ceramic washbasin incl. motion sensor 6000 Kelvin EEC A-A++</i></p>				LED96K	 	196						
						<table border="1"> <thead> <tr> <th>PG1 Dickkante/ thick edge</th> <th>PG2 Matt/matt</th> <th>PG3 Glanz/gloss</th> </tr> </thead> <tbody> <tr> <td>505</td> <td>561</td> <td>660</td> </tr> </tbody> </table>	PG1 Dickkante/ thick edge	PG2 Matt/matt	PG3 Glanz/gloss	505	561	660
PG1 Dickkante/ thick edge	PG2 Matt/matt	PG3 Glanz/gloss										
505	561	660										
 <p>Waschtisch-Unterschrank 2 Türen</p> <p><i>washbasin base cabinet 2 doors</i></p>	96	49,5	44	FWUKT96								
 <p>Waschtisch-Unterschrank 2 Auszüge</p> <p><i>washbasin base cabinet 2 extensions</i></p>	96	49,5	44	FWUK96								
 <p>Spiegelschrank, 3 Spiegeltüren 6 Glaseinlegeböden, LED Aufbauleuchte LL94 8,9 W 6000 Kelvin, inkl. Schalter/Steckdose EEK A-A++</p> <p><i>mirror cabinet, 3 mirror doors 6 glass shelves, LED lighting LL94 8,9 W 6000 K, incl. switch/socket EEC A-A++</i></p>	100	68,2/ 74,2	17,6	FSPSR100		1392						
 <p>Spiegelpaneel Oberboden mit 2 LED-Streifen á 7,7 W 6000 Kelvin, inkl. Schalter mittig unten EEK A-A++</p> <p><i>mirror panel top with 2 LED stripes each 7,7 W 6000 Kelvin, incl. switch center below EEC A-A++</i></p>	100	68,2/ 70,1	3/ 10	FSP100		793						



EEK/EEC=Energieeffizienzklasse/energy efficiency category

Beschreibung Description	Maße in cm Dimensions in cm			Artikel-Nr. Article no.	Türanschlag Door stop	Identnummer ID number
	B/W	H	T/D			

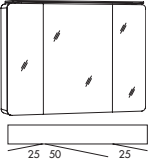
 <p>Keramik-Waschtisch inkl. Überlauf und Befestigungsmaterial</p> <p><i>ceramic washbasin incl. overflow and fastener</i></p>	100	5	44,5	KWEL100		798







						PG1 Dickkante/ thick edge	PG2 Matt/matt	PG3 Glanz/gloss
 <p>Waschtisch-Unterschrank 2 Türen</p> <p><i>washbasin base cabinet 2 doors</i></p>	96	49,5	44	FWUKT96		505	561	660
 <p>Waschtisch-Unterschrank 2 Auszüge</p> <p><i>washbasin base cabinet 2 extensions</i></p>	96	49,5	44	FWUK96		711	790	930

 <p>Spiegelschrank, 3 Spiegeltüren 6 Glaseinlegeböden, LED Aufbauleuchte LL94 8,9 W 6000 Kelvin, inkl. Schalter/Steckdose EEK A-A++</p> <p><i>mirror cabinet, 3 mirror doors 6 glass shelves, LED lighting LL94 8,9 W 6000 K, incl. switch/socket EEC A-A++</i></p>	100	68,2/ 74,2	17,6	FSPSR100		1392





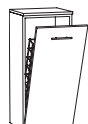
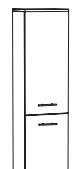
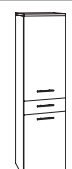

 <p>Spiegelpaneel Oberboden mit 2 LED-Streifen á 7,7 W 6000 Kelvin, inkl. Schalter mittig unten, EEK A-A++</p> <p><i>mirror panel top with 2 LED stripes each 7,7 W 6000 Kelvin, incl. switch center below EEC A-A++</i></p>	100	68,2/ 70,1	3/ 10	FSP100		793

EEK/EEC=Energieeffizienzklasse/energy efficiency category

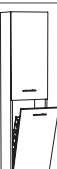

3020 »Beistellschränke/ side cabinets«

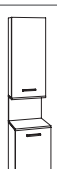
	Beschreibung Description	Maße in cm Dimensions in cm			Artikel-Nr. Article no.	Türanschlag Door stop	Identnummer ID number		
		B/W	H	T/D			PG1 Dickkante/ thick edge	PG2 Matt/matt	PG3 Glanz/gloss
	Oberschrank 1 Tür, 2 Glaseinlegeböden <i>top cabinet 1 door, 2 glass shelves</i>	40	57,4	17,6	OT4L OT4R	Links/ <i>left</i> Rechts/ <i>right</i>	487	559	735
	Unterschrank inkl. Abdeckplatte 1 Tür, 2 Glaseinlegeböden <i>base cabinet incl. top 1 door, 2 glass shelves</i>	40	59,2	34,8	UT4FL UT4FR	Links/ <i>left</i> Rechts/ <i>right</i>	538	614	870
	Highboard inkl. Abdeckplatte 1 Tür 2 Glaseinlegeböden <i>high cabinet incl. top 1 door 2 glass shelves</i>	40	91,2	34,8	HBT4FL HBT4FR	Links/ <i>left</i> Rechts/ <i>right</i>	608	676	970
	Highboard inkl. Abdeckplatte 1 Tür, 1 Schubkasten 2 Glaseinlegeböden <i>high cabinet incl. top 1 door, 1 drawer 2 glass shelves</i>	40	91,2	34,8	HBST4FL HBST4FR	Links/ <i>left</i> Rechts/ <i>right</i>	905	995	1264
	Highboard inkl. Abdeckplatte 1 Tür/Wäschekippe <i>high cabinet incl. top 1 door/linen bin</i>	40	91,2	34,8	HBW4F		714	794	1088
	Mittelschrank inkl. Abdeckplatte 2 Türen 3 Glaseinlegeböden <i>medium cabinet incl. top 2 doors 3 glass shelves</i>	40	148,8	34,8	MTT4FL MTT4FR	Links/ <i>left</i> Rechts/ <i>right</i>	982	1080	1470
	Mittelschrank inkl. Abdeckplatte 2 Türen, 1 Schubkasten 3 Glaseinlegeböden <i>medium cabinet incl. top 2 doors, 1 drawer 3 glass shelves</i>	40	148,8	34,8	MTST4FL MTST4FR	Links/ <i>left</i> Rechts/ <i>right</i>	1215	1294	1654
	Mittelschrank inkl. Abdeckplatte 4 Türen 3 Glaseinlegeböden <i>medium cabinet incl. top 4 doors 3 glass shelves</i>	60	148,8	34,8	MTT6F		1485	1679	2043
	Mittelschrank inkl. Abdeckplatte 2 Türen, 2 Auszüge 2 Glaseinlegeböden <i>medium cabinet incl. top 2 doors, 2 extensions 2 glass shelves</i>	60	148,8	34,8	MTAA6F		1588	1764	2234

3020 »Beistellschränke/ side cabinets«

Beschreibung Description	Maße in cm Dimensions in cm			Artikel-Nr. Article no.	Türanschlag Door stop	Identnummer ID number		
	B/W	H	T/D			PG1 Dickkante/ thick edge	PG2 Matt/matt	PG3 Glanz/gloss
 <p>Kombi-Mittelschrank inkl. Abdeckplatte 1 Tür, 1 Nische, 1 Auszug 2 Glaseinlegeböden</p> <p><i>medium cabinet incl. top 1 door, 1 open case, 1 extension 2 glass shelves</i></p>	40	148,8	17,6/ 34,8	MTNA4FL MTNA4FR	Links/ <i>left</i> Rechts/ <i>right</i>	1321	1557	2079
 <p>Kombi-Mittelschrank inkl. Abdeckplatte 1 Tür, 1 Nische mit 2,0 W LED-Strahler, 6000 Kelvin, 1 Auszug 2 Glaseinlegeböden EEK A-A++</p> <p><i>medium cabinet incl. top 1 door, 1 open case with 2,0 W LED-spotlight, 6000 Kelvin, 1 extension 2 glass shelves EEC A-A++</i></p>	40	148,8	17,6/ 34,8	MTNAL4FL MTNAL4FR	Links/ <i>left</i> Rechts/ <i>right</i>	1551	1787	2309
 <p>Hochschrank 2 Türen 4 Glaseinlegeböden</p> <p><i>tower cabinet 2 doors 4 glass shelves</i></p>	40	178,7	34,8	HTT4L HTT4R	Links/ <i>left</i> Rechts/ <i>right</i>	1034	1129	1499
 <p>Hochschrank 1 Tür / 1 Wäschekippe 2 Glaseinlegeböden</p> <p><i>tower cabinet 1 door / 1 linen bin 2 glass shelves</i></p>	40	178,7	34,8	HTW4L HTW4R	Links/ <i>left</i> Rechts/ <i>right</i>	1134	1229	1588
 <p>Hochschrank 2 Türen, 1 Schubkasten 3 Glaseinlegeböden</p> <p><i>tower cabinet 2 doors / 1 drawer 3 glass shelves</i></p>	40	178,7	34,8	HTST4L HTST4R	Links/ <i>left</i> Rechts/ <i>right</i>	1292	1418	1764
 <p>Kombi-Hochschrank 2 Türen, 1 Nische 4 Glaseinlegeböden</p> <p><i>tower cabinet 2 doors, 1 open case 4 glass shelves</i></p>	40	179,2	17,6/ 34,8	HTNT4L HTNT4R	Links/ <i>left</i> Rechts/ <i>right</i>	1239	1439	1915
 <p>Kombi-Hochschrank 2 Türen, 1 Nische mit 2,0 W LED-Strahler, 6000 Kelvin 4 Glaseinlegeböden EEK A-A++</p> <p><i>tower cabinet 2 doors, 1 open case with 2,0 W LED-spotlight, 6000 Kelvin 4 glass boards EEC A-A++</i></p>	40	179,2	17,6/ 34,8	HTNTL4L HTNTL4R	Links/ <i>left</i> Rechts/ <i>right</i>	1469	1669	2145

EEK/EEC=Energieeffizienzklasse/energy efficiency category

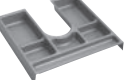
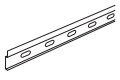
Beschreibung Description	Maße in cm Dimensions in cm			Artikel-Nr. Article no.	Türanschlag Door stop	Identnummer ID number
	B/W	H	T/D			
 <p>Handtuchhalter 1-armig (Befestigung am Schrank) ausziehbar</p> <p><i>towel rail 1-arm (fastening on the cabinet) pull out</i></p>	7,5	4	32,5/ 50	HH133		112
 <p>Handtuchhalter 2-armig (Befestigung am Schrank) ausziehbar</p> <p><i>towel rail 2-arms (fastening on the cabinet) pull out</i></p>	10,5	4	32,5/ 50	HH233		141
 <p>Handtuchhalter 1-armig (Befestigung am Schrank)</p> <p><i>towel rail 1-arm (fastening on the cabinet)</i></p>	5	1	33	HHF133		85
 <p>Handtuchhalter verchromt (Befestigung am Schrank)</p> <p><i>chromed towel rail (fastening on the cabinet)</i></p>	5	2,5	40	RHH		189
 <p>Spiegelschrank-Unterbaubeleuchtung 5,8 W LED EEK A-A++ (für Spiegelschrank ab 60 cm Breite), 6000 Kelvin Beleuchtung kann unter Spiegel- schränken und unter Regalen verbaut werden.</p> <p><i>base lighting for mirror cabinet 5,8 W LED EEC A-A++ (for mirror cabinet ex 60 cm width), 6000 Kelvin Lighting can be installed under mirror cabinets and under shelves.</i></p>	57			WTBP60		289
 <p>Spiegelschrank-Unterbaubeleuchtung 3,4 W LED EEK A-A++ (für Spiegel- schrank ab 80 cm Breite) 6000 Kelvin Beleuchtung kann nur unter Spiegel- schränke und nicht unter Regale verbaut werden.</p> <p><i>base lighting for mirror cabinet 3,4 W LED EEC A-A++ (for mirror cabinet ex 80 cm width) 6000 Kelvin Lighting only can be installed under mirror cabinets and not under shelves.</i></p>	70			WTB70		265
 <p>Schubkasteneinsatz (Kunststoff) für oberen Auszug vom WT-Unterschrank</p> <p><i>drawer insert part (plastic) for top drawer from base cabinet</i></p>	33,7	4,3	33	SMBEG3		59
 <p>Schubkasteneinsatz (Kunststoff) für Schubkasten B: 40 cm / T: 30 cm für Beistellschränke</p> <p><i>drawer insert part (plastic) for drawer 40 cm w: 40cm / d: 30 cm for side cabinets</i></p>	30,9	4,5	28	SEG4		66
 <p>Montageschiene inkl. Befestigungsmaterial</p> <p><i>mounting rail incl. fastening material</i></p>	210			MS210		125

EEK/EEC=Energieeffizienzklasse/energy efficiency category

FWUMT76
FMW80

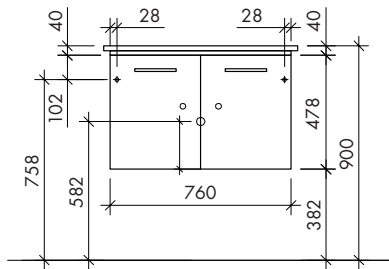

FWUMT96
FMW100

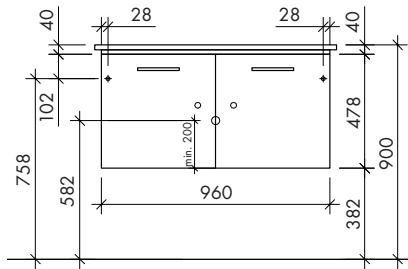

FWUM76
FMW80

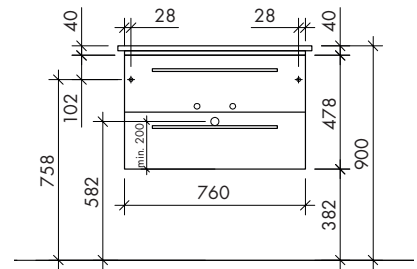

FWUM96
FMW100

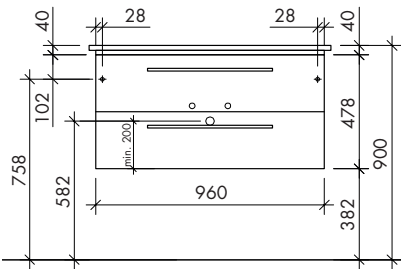

FWUKT76
FKW80

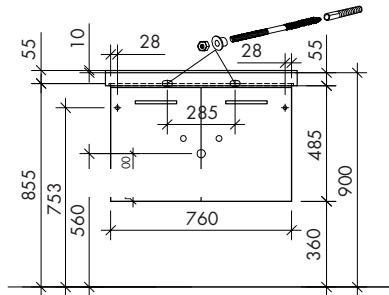

FWUKT96
FKW100

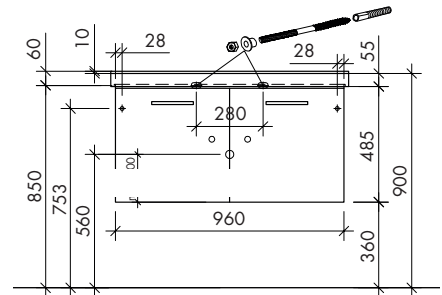

FWUK76
FKW80

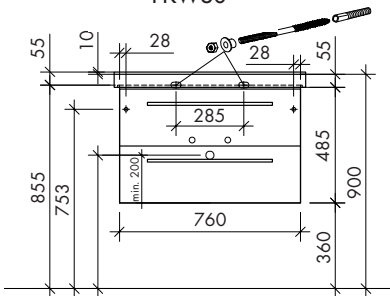

FWUK96
FKW100

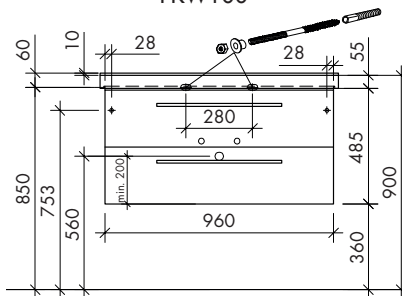

FWUIT76
MWIDE8

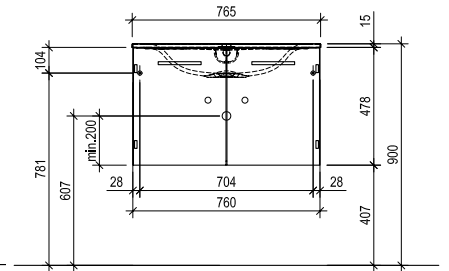

FWUIT96
MWIDE10

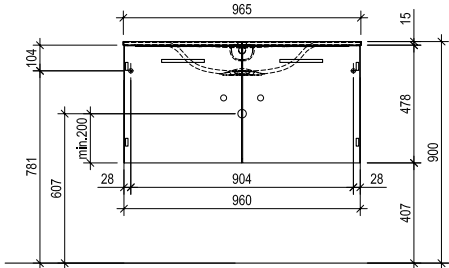

FWUI76
MWIDE8

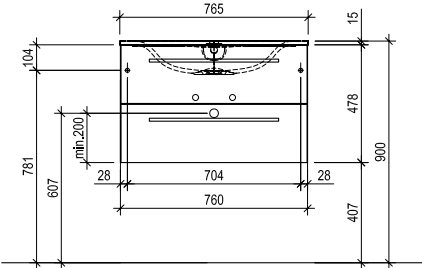

FWUI96
MWIDE10

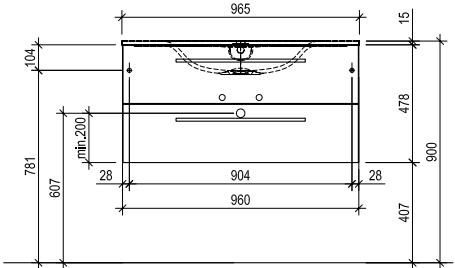

KWELI80

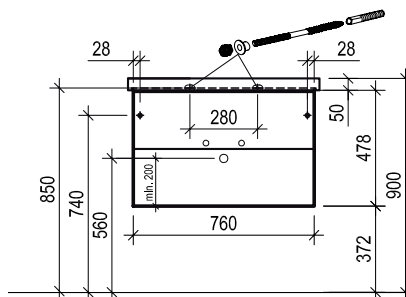

KWELI100

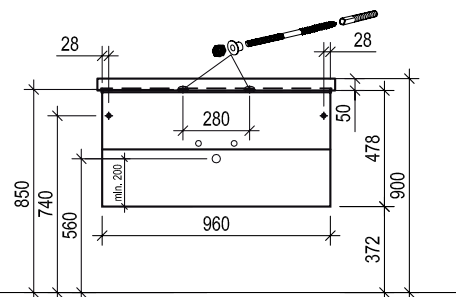

! Achtung: Die Montage muss durch fachkundige Personen erfolgen. Der Untergrund zur Wandbefestigung ist vor Montage zu prüfen. Bitte wählen Sie entsprechend das geeignete Befestigungsmaterial. Fehlerhafte Montagen können das Möbel beschädigen oder dessen Funktion dauerhaft beeinträchtigen. Für Sach- und Personenschäden übernehmen wir im Falle einer unsachgemäßen Montage keine Haftung.
 Attention: Assembly must be carried out by skilled personnel. The subsurface for the wall mounting must be checked before assembly. Please select a suitable mounting material. Faulty assembly can damage furniture or permanently impair its function. We will not be held responsible for damage to material or persons in the case of improper assembly.

3020 »Maße/dimensions«

Bohrlochhöhen für Schraubhaken, Anschlussmaße und Abflusshöhen/drilling point for screw hooks, dimensions for mounting and drain

FSPSR60

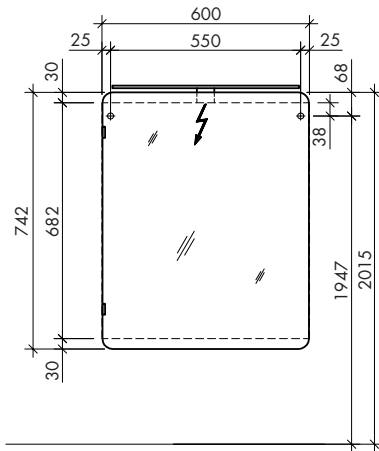

FSPSR80
FSPSR80S

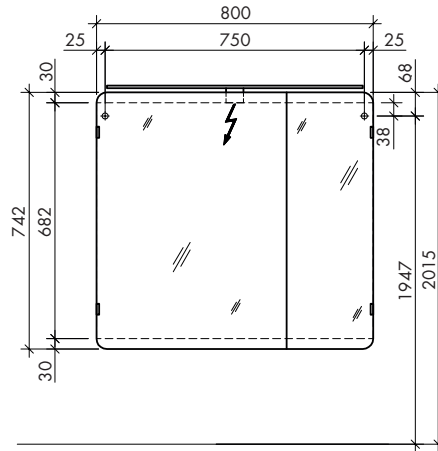

FSPSR100

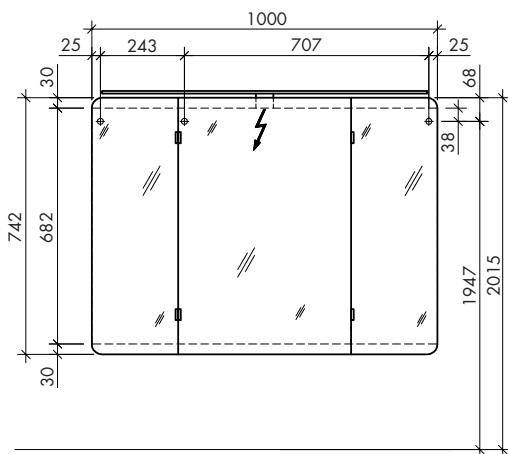

FSP80/100

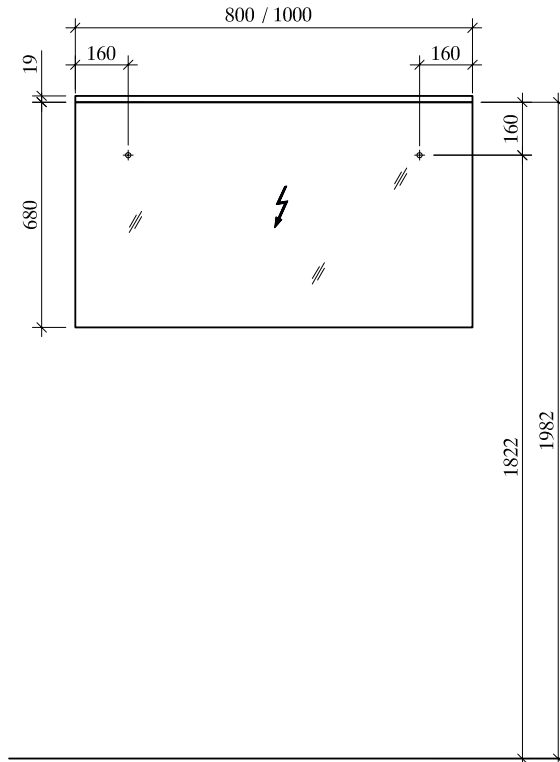

! Achtung: Die Montage muss durch fachkundige Personen erfolgen. Der Untergrund zur Wandbefestigung ist vor Montage zu prüfen. Bitte wählen Sie entsprechend das geeignete Befestigungsmaterial. Fehlerhafte Montagen können das Möbel beschädigen oder dessen Funktion dauerhaft beeinträchtigen. Für Sach- und Personenschäden übernehmen wir im Falle einer unsachgemäßen Montage keine Haftung.
 Attention: Assembly must be carried out by skilled personnel. The subsurface for the wall mounting must be checked before assembly. Please select a suitable mounting material. Faulty assembly can damage furniture or permanently impair its function. We will not be held responsible for damage to material or persons in the case of improper assembly.

