

# Möbel LETZ

*Finden und Wohlfühlen*



## Typenplan

Cocoa Island von Bretz - Ecksofa Variante rechts smaragdgrün

### **Wichtiger Hinweis für Sie**

Etwaige Hinweise des Herstellers in dieser Produktinformation, die sich auf die Gewährleistung beziehen, haben für Sie keinerlei Bindungswirkung und können von Ihnen ignoriert werden. Ihre gesetzlichen Gewährleistungsrechte als Verbraucher uns gegenüber, als Ihrem Verkäufer, werden dadurch in keiner Weise berührt oder eingeschränkt. Sie können sich wegen aller Mängel jederzeit an uns wenden. Darüber hinaus gehende Herstellergarantien bleiben natürlich unberührt. Dieser Artikel wird hergestellt von Bretz Wohnträume GmbH, Alexander-Bretz-Straße 2, 55457 Gensingen, Deutschland

Möbel Letz GmbH  
Am Gewerbepark 11  
06895 Zahna-Elster

Tel.: 035383 - 6018 50

Fax.: 035383 - 6018 17

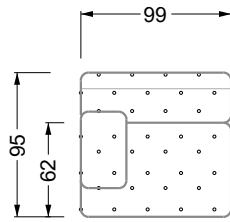

TNli

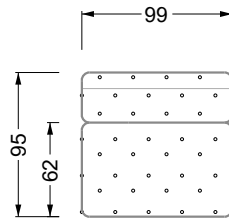

TN

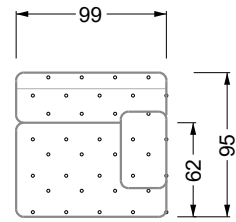

TNre

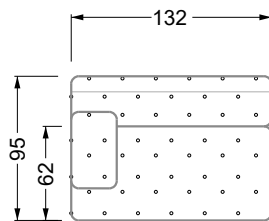

UNli

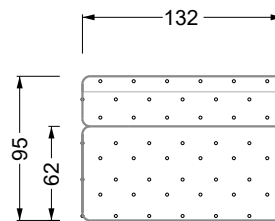

UN

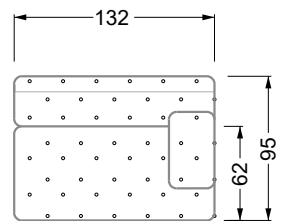

UNre

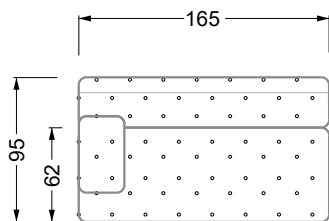

VNli

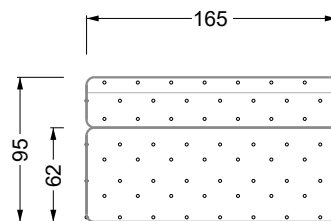

VN

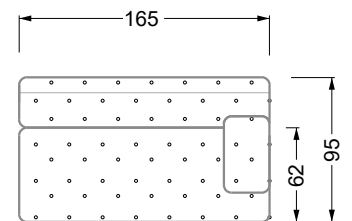

VNre

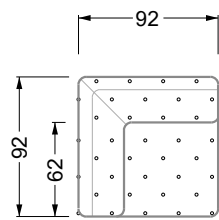

SN

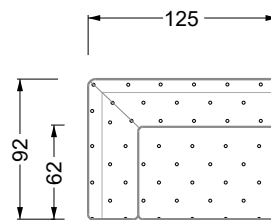

Sli

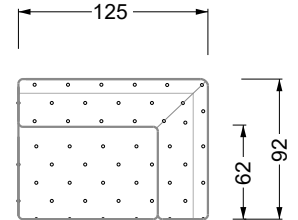

Sre

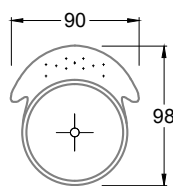

A

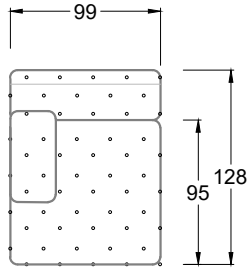

Tli

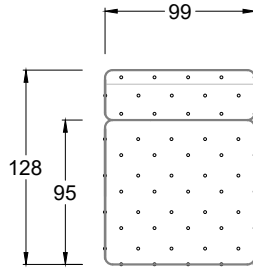

T

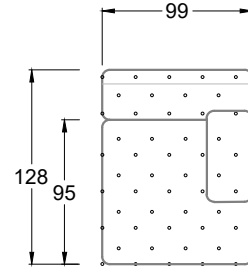

Tre

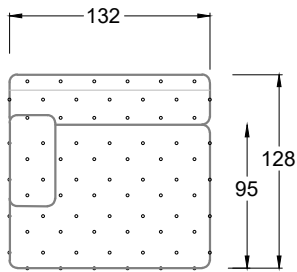

Uli

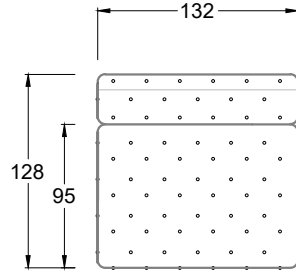

U

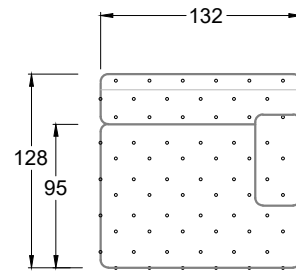

Ure

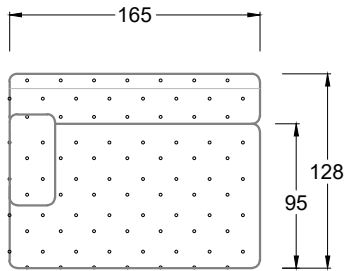

Vli

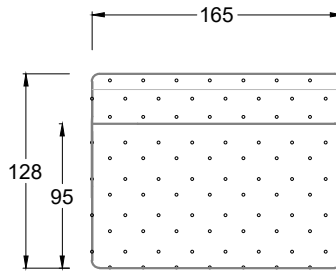

V

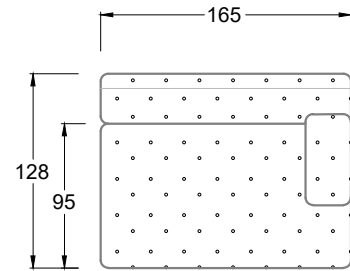

Vre

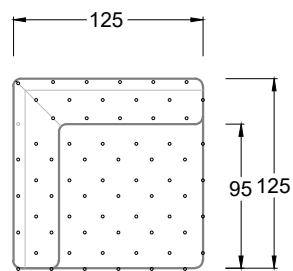

S

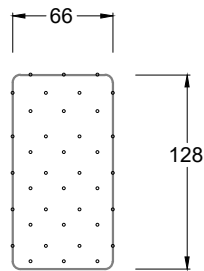

CE

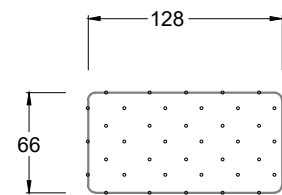

CD

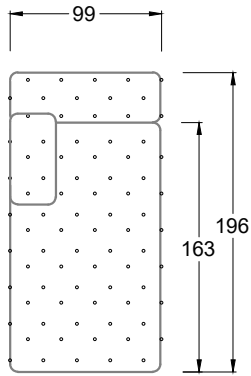

TDli

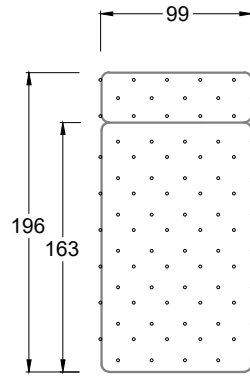

TD

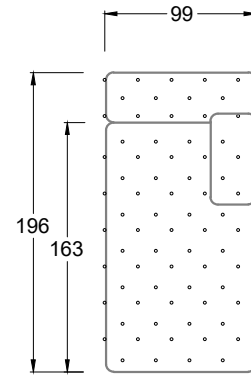

TDre

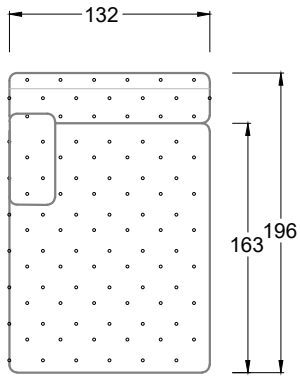

UDli

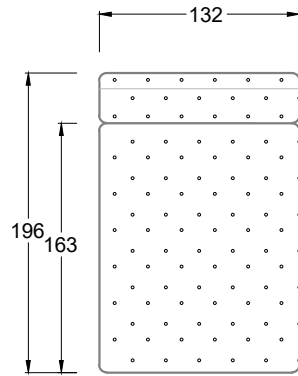

UD

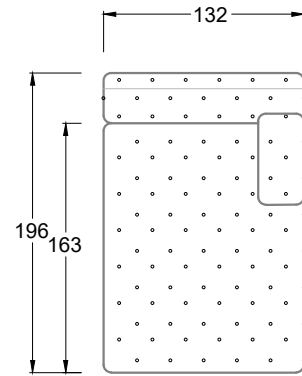

UDre

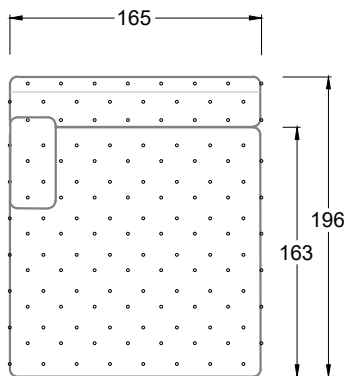

VDli

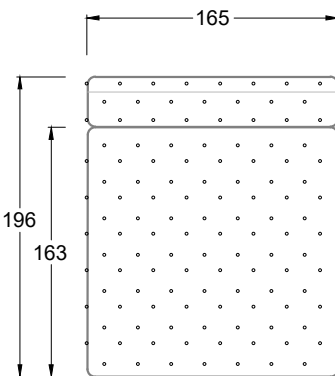

VD

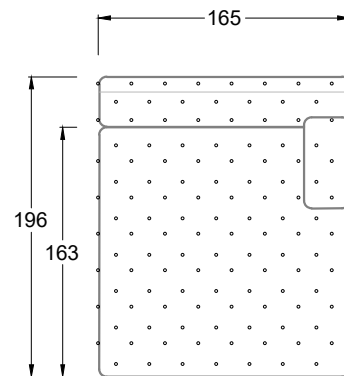

VDre

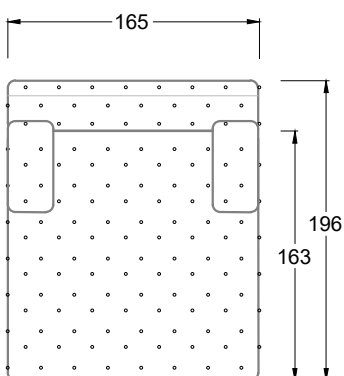

VDlr

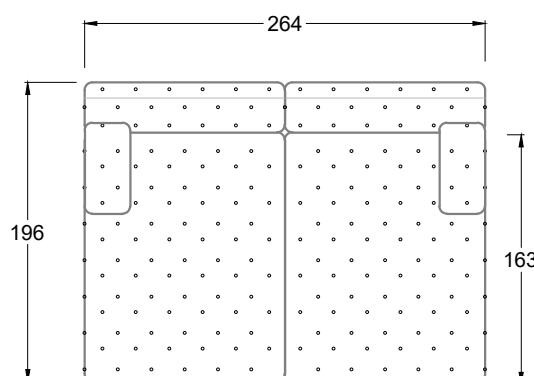

UDli

UDre

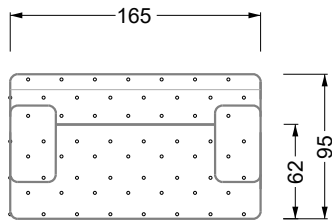

VN lr

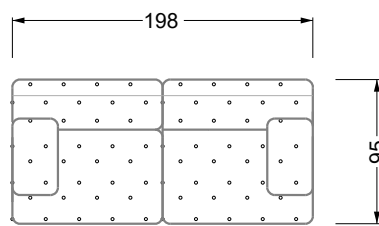

TNli TNre

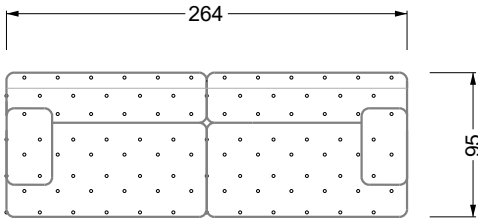

UNli UNre

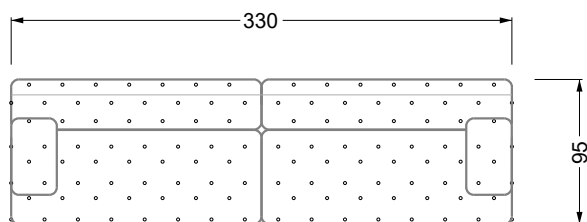

VNli VNre

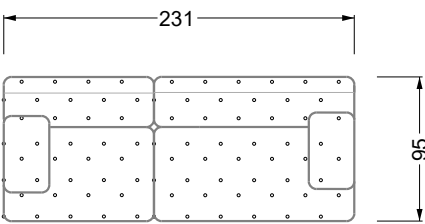

TNli UNre

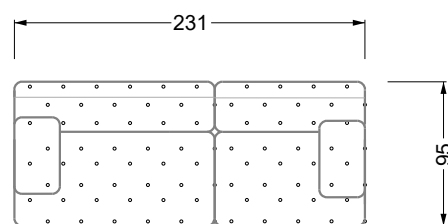

UNli TNre

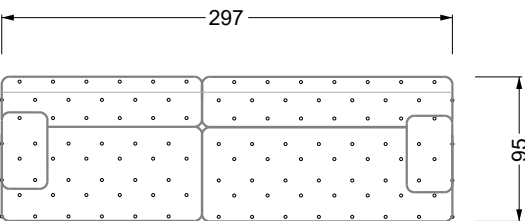

UNli VNre

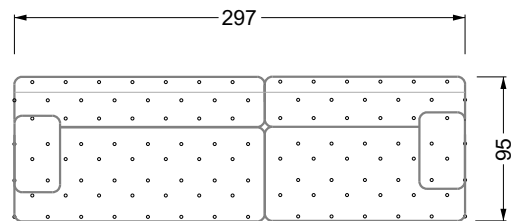

VNli UNre

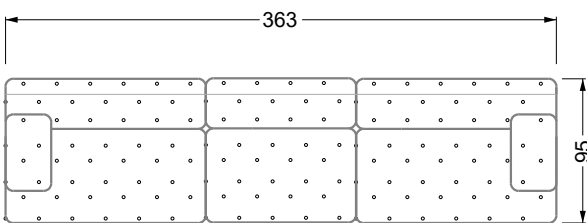

UNli TN UNre

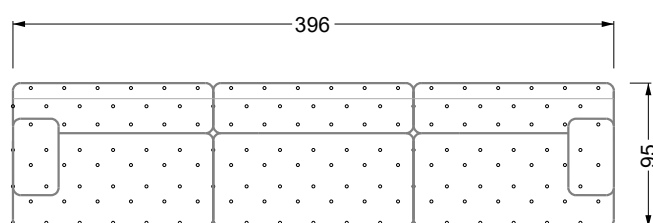

UNli UN UNre

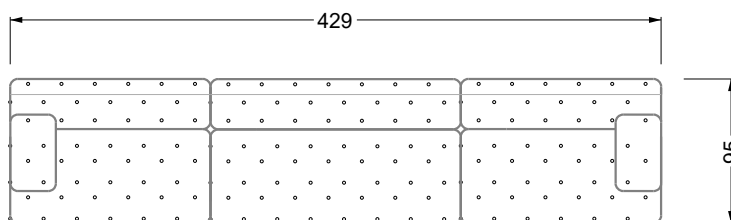

UNli VN UNre

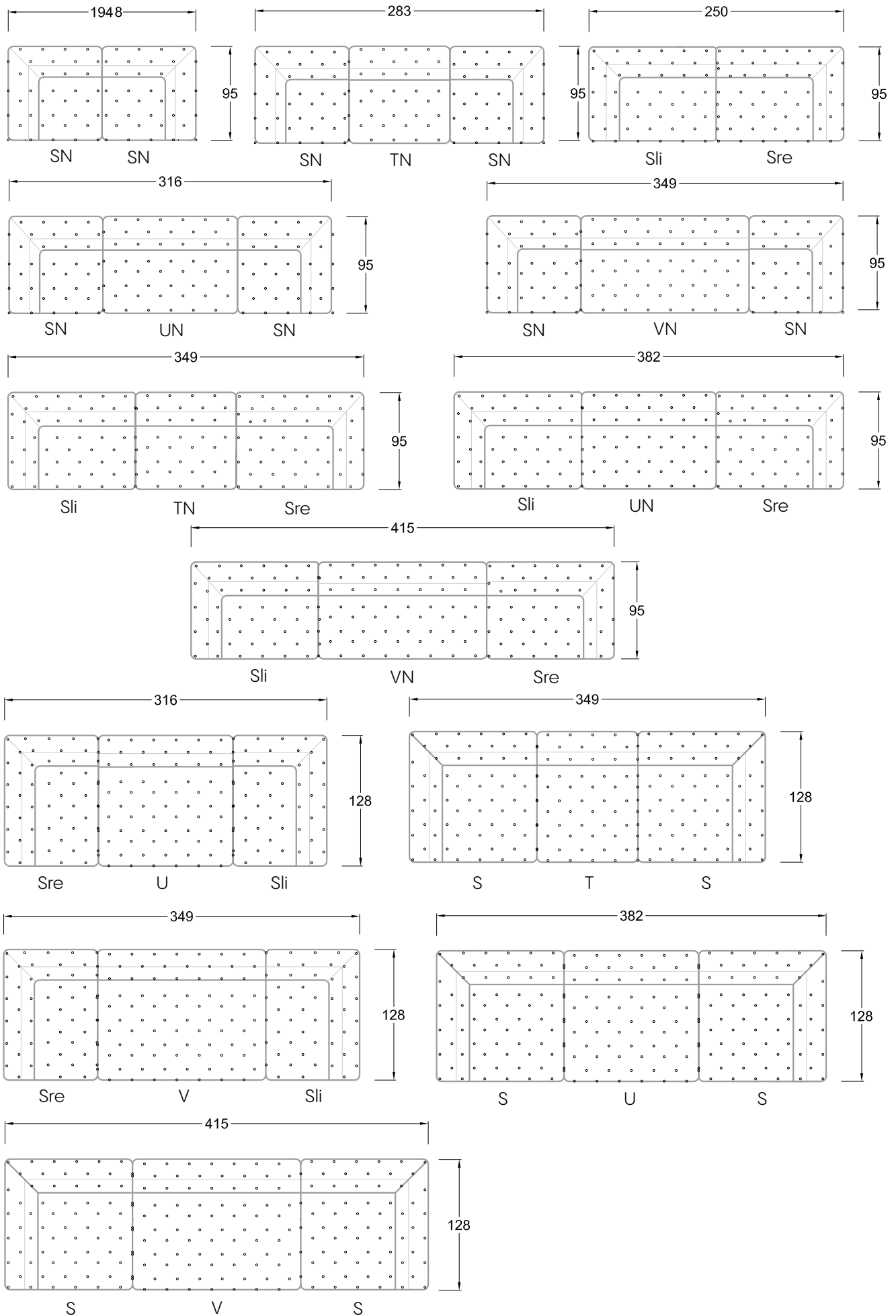

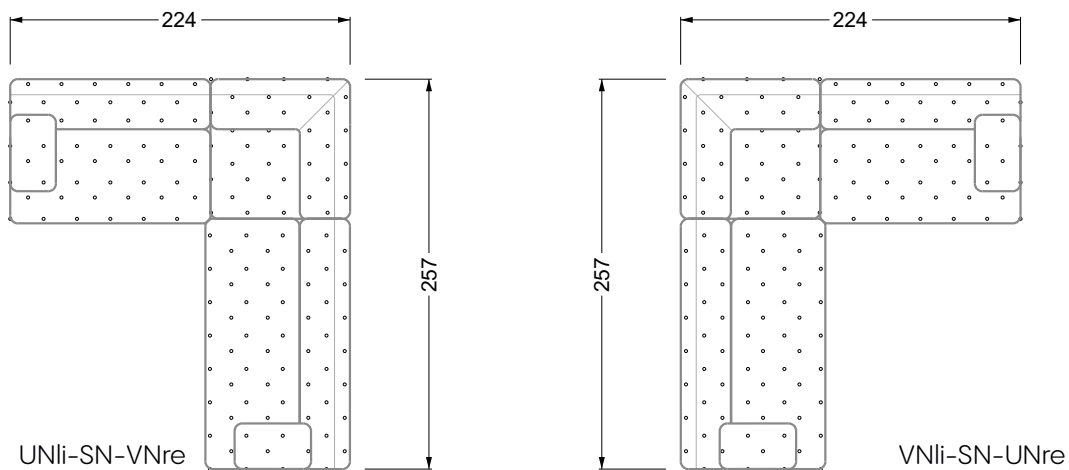
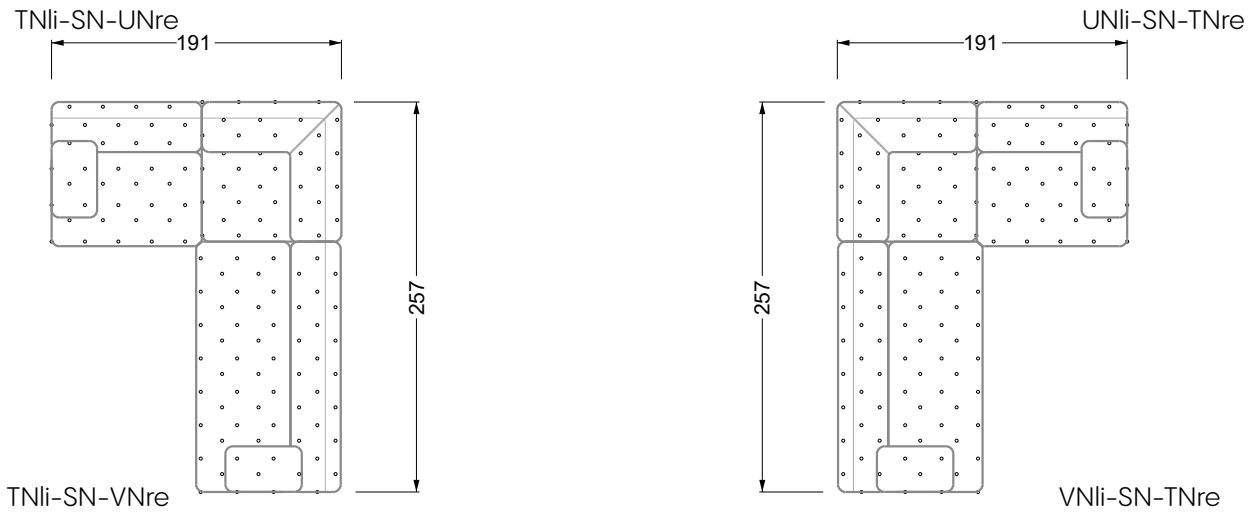
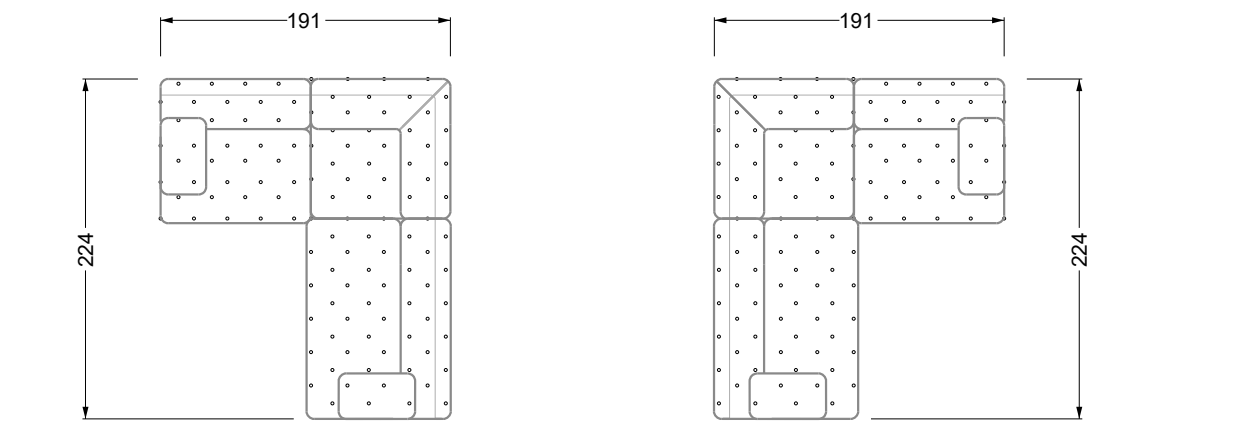
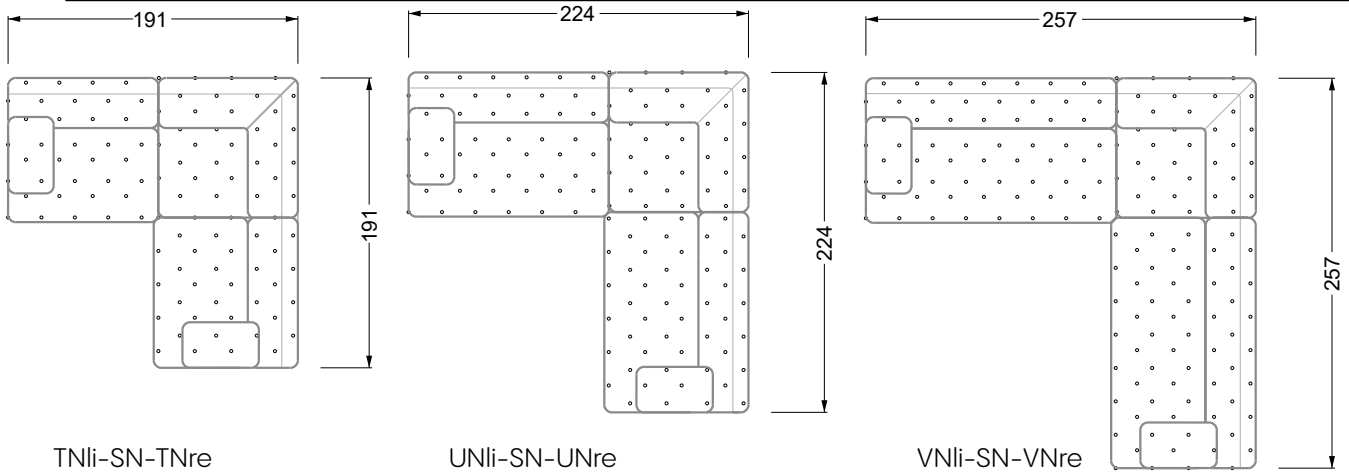

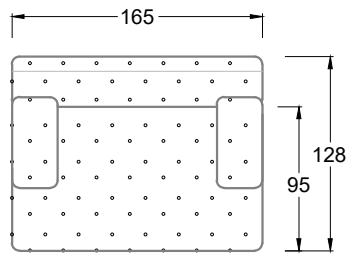

**E**

V lr

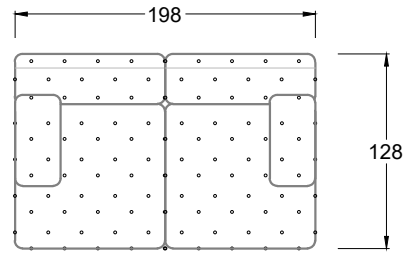

**F**

Tli

Tre

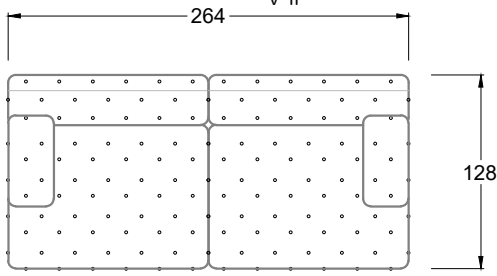

**G**

Uli

Ure

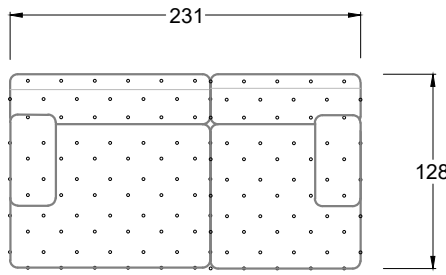

Uli

Tre

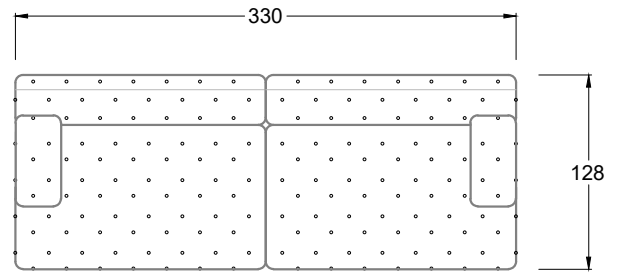

Vli

Vre

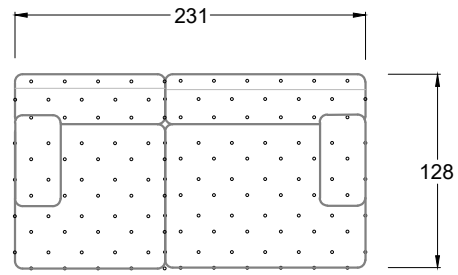

Tli

Ure

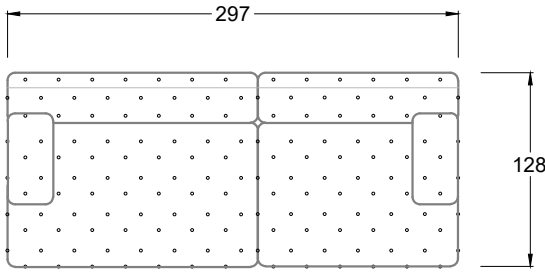

Vli

Ure

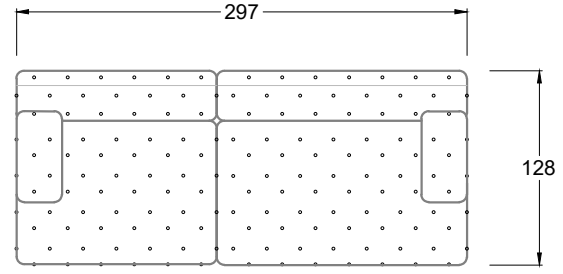

Uli

Vre

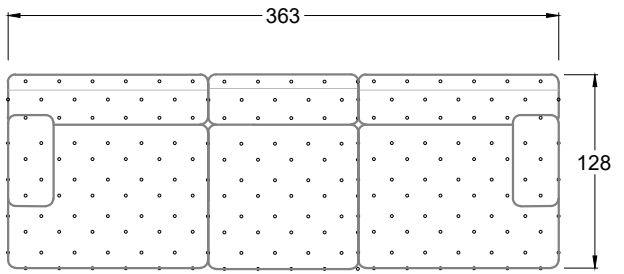

Uli

T

Ure

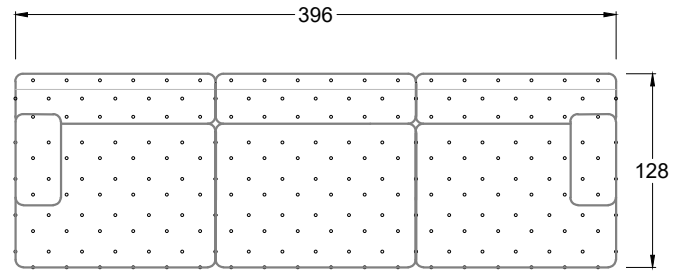

Uli

U

Ure

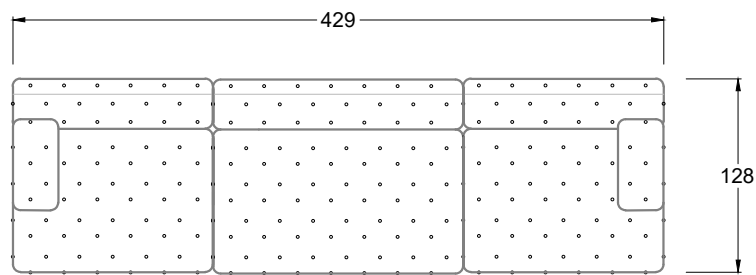

Uli

V

Ure



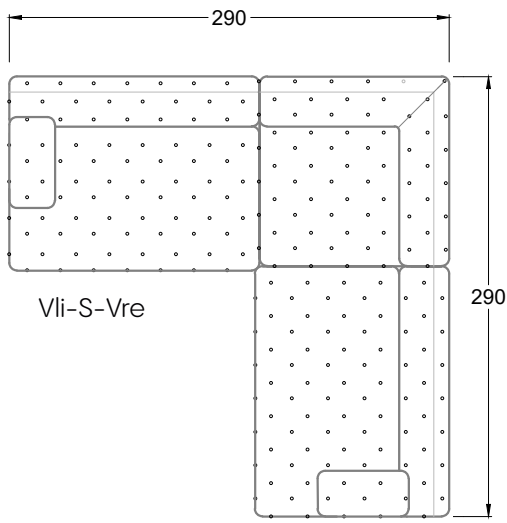

Vli-S-Vre

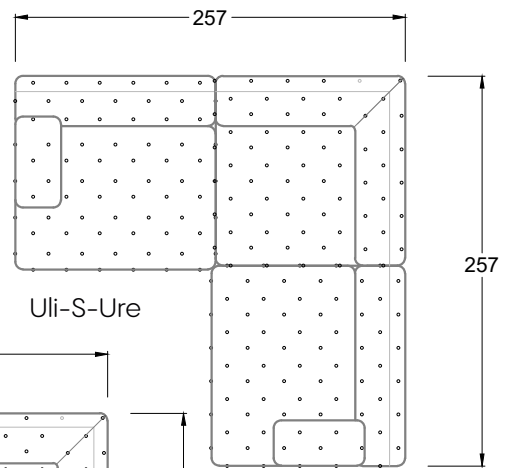

Uli-S-Ure

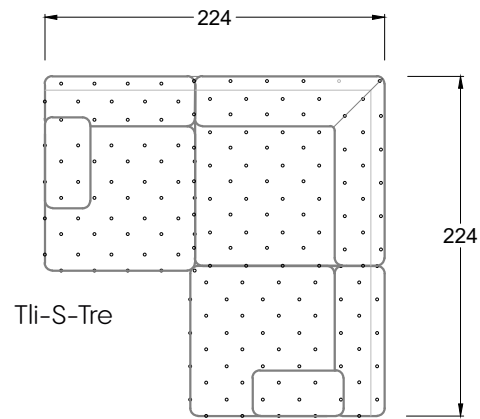

Tli-S-Tre

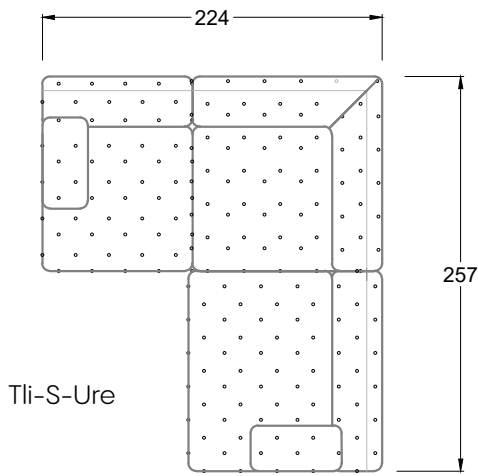

Tli-S-Ure

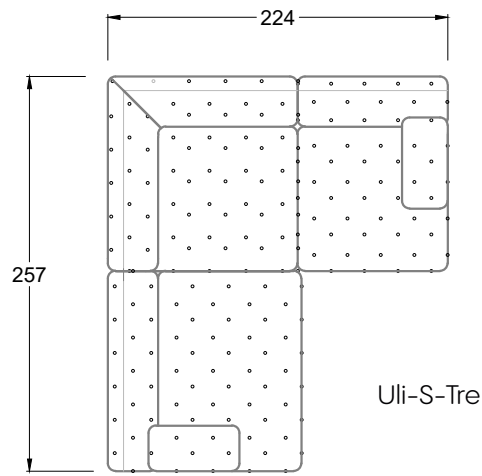

Uli-S-Tre

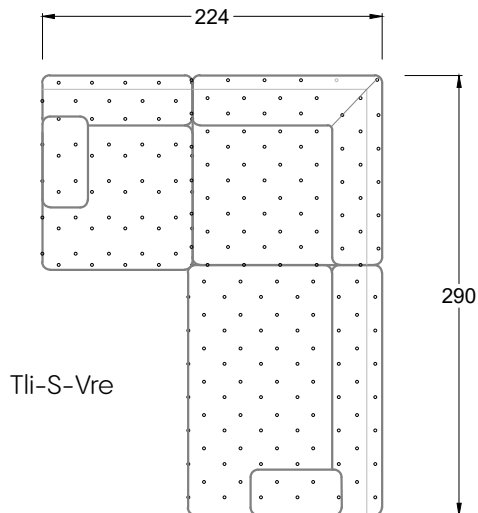

Tli-S-Vre

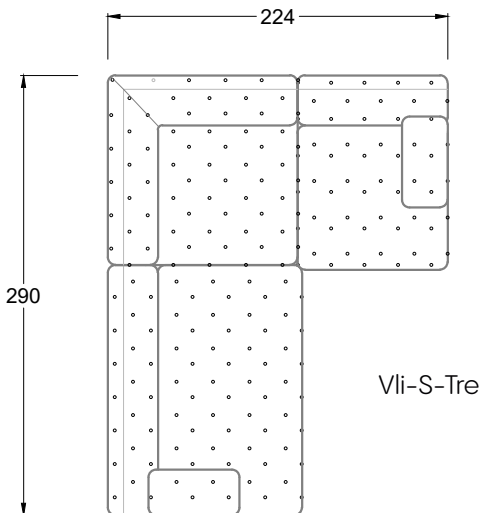

Vli-S-Tre

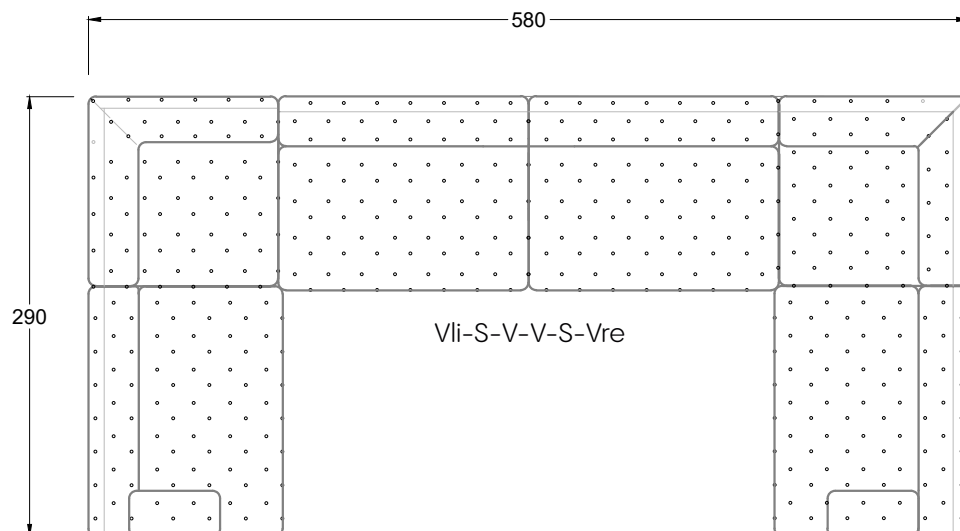
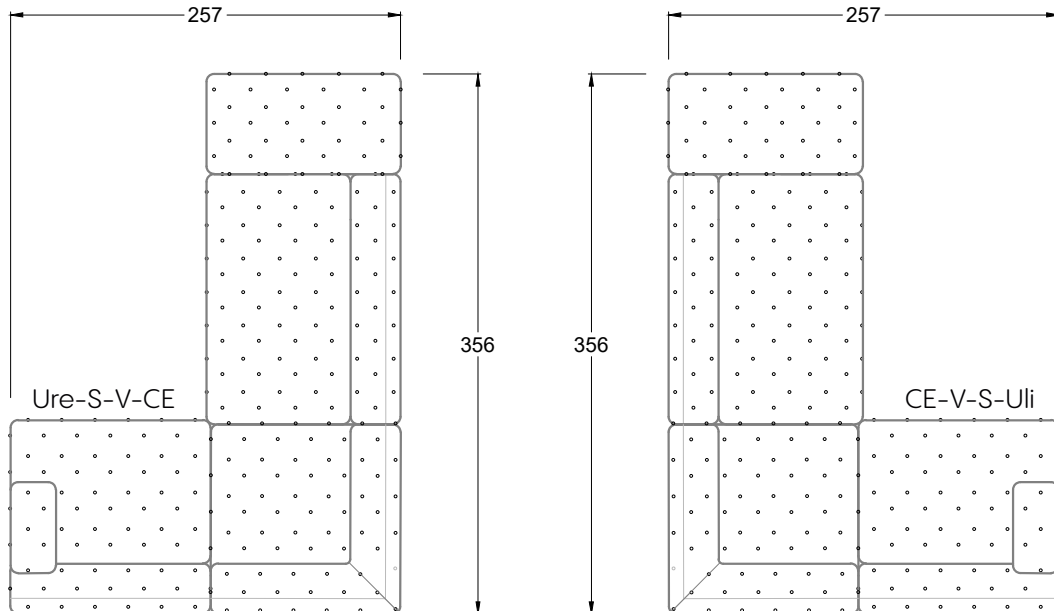
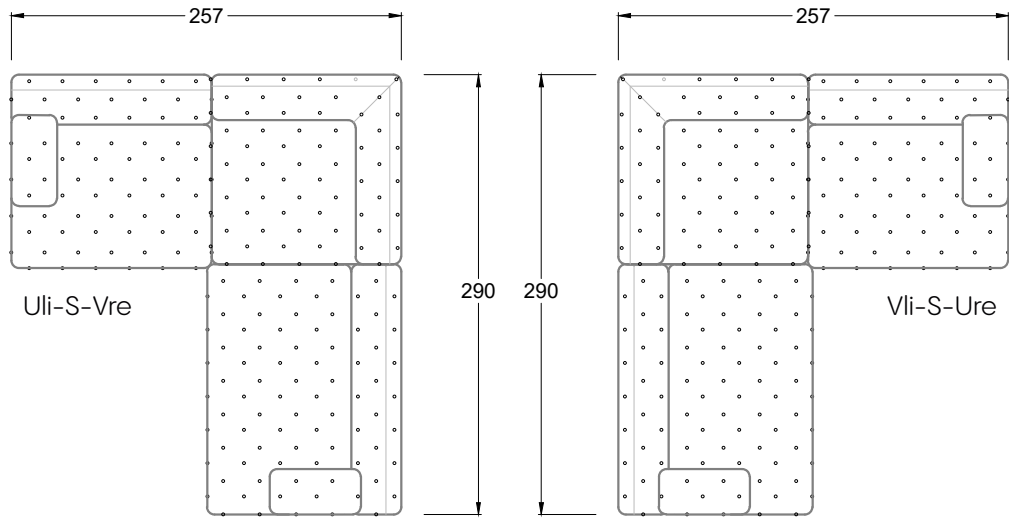

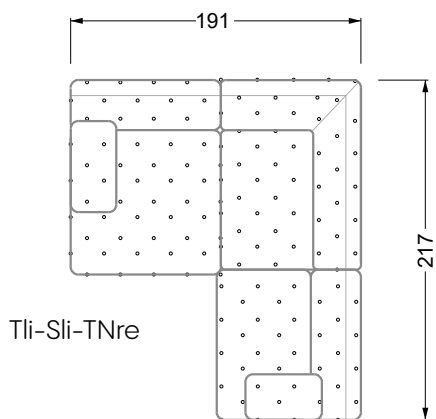

Tli-Sli-TNre

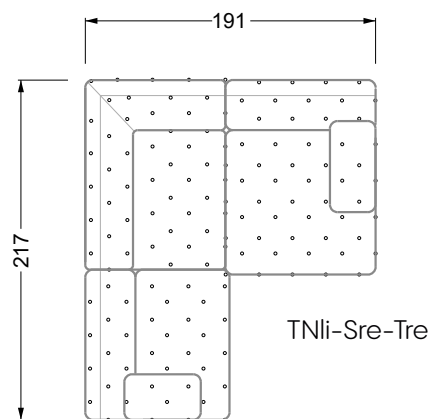

TNli-Sre-Tre

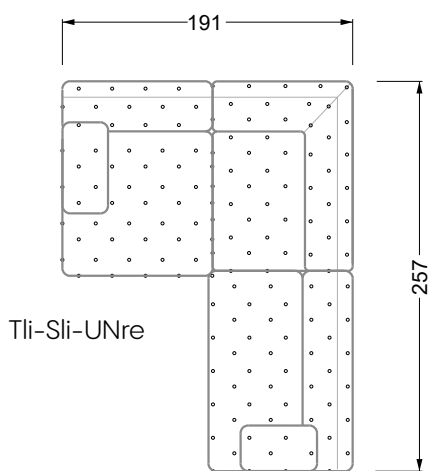

Tli-Sli-UNre

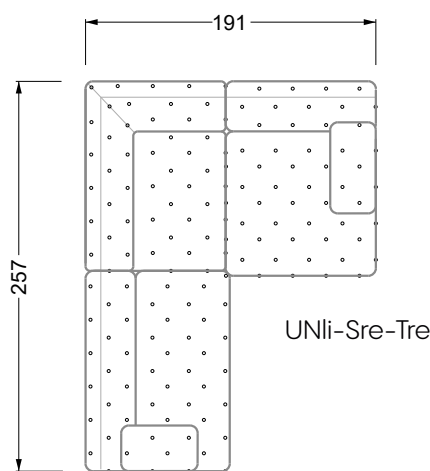

UNli-Sre-Tre

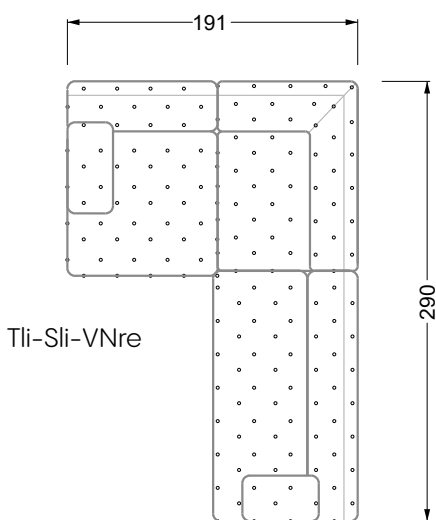

Tli-Sli-VNre

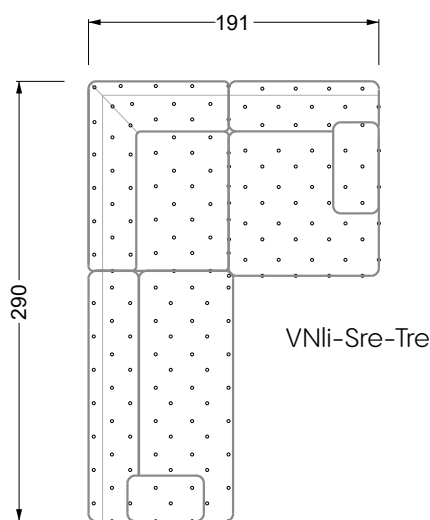

VNli-Sre-Tre

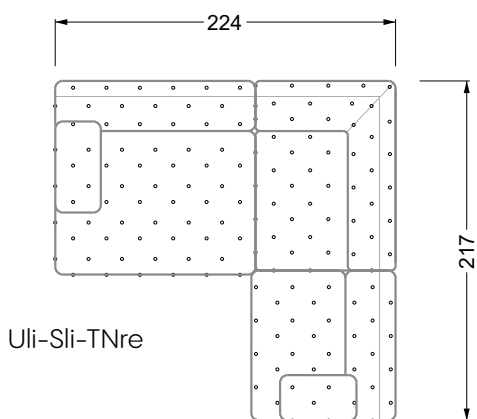

Uli-Sli-TNre

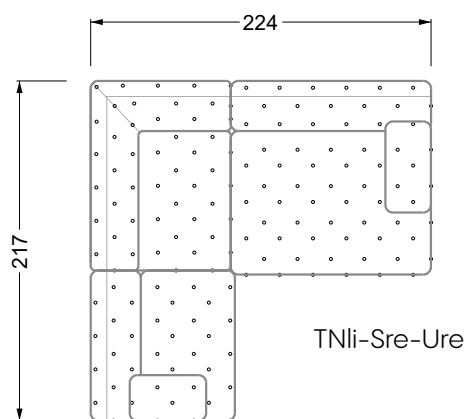

TNli-Sre-Ure

