

Möbel LETZ

Finden und Wohlfühlen



Typenplan

3400 von Marlin - Badezimmer in Eiche Struktur

Wichtiger Hinweis für Sie

Etwaige Hinweise des Herstellers in dieser Produktinformation, die sich auf die Gewährleistung beziehen, haben für Sie keinerlei Bindungswirkung und können von Ihnen ignoriert werden. Ihre gesetzlichen Gewährleistungsrechte als Verbraucher uns gegenüber, als Ihrem Verkäufer, werden dadurch in keiner Weise berührt oder eingeschränkt. Sie können sich wegen aller Mängel jederzeit an uns wenden. Darüber hinaus gehende Herstellergarantien bleiben natürlich unberührt. Dieser Artikel wird hergestellt von MARLIN Badmöbel, Jaka-Str. 3, 32351 Stemwede, Deutschland, marlin@marlinbad.de

Möbel Letz GmbH
Am Gewerbepark 11
06895 Zahna-Elster

Tel.: 035383 - 6018 50

Fax.: 035383 - 6018 17

Piktogramme/pictograms



Mineralmarmor Waschtisch
Marble minerals washbasin



LED Lichtfarbe kalt
LED colour temperature cold



LED mit Bewegungssensor
LED with motion sensor



Keramik Waschtisch
Ceramic washbasin



LED Lichtfarbe warm
LED colour temperature warm



LED mit Sensorschalter
LED with sensor switch



Glas Waschtisch
Glass washbasin



LED Lichtfarbe regelbar,
Helligkeit dimmbar
LED colour temperature adjust-
able, brightness dimmable



LED Lichtfarbe schaltbar bzw. regelbar
LED colour temperature adjustable

Keramik Waschtisch weiß alpin Glanz (ASK)

Ceramic washbasin gloss alpine white (ASK)

≈ Beckenmaße in cm (BxHxT)
basin dimensions in cm (WxHxD)

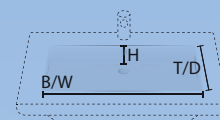

KWSOF8 | 58 x 11,5 x 31 cm



Detail



KWSOF10 | 58 x 11,5 x 31 cm

Befestigungsmaterial für Keramikwaschtisch MONK-4 MONK-4 fastening material for ceramic washbasin

Wir empfehlen eine Montage nur durch einen qualifizierten Monteur/Installateur. Keine Haftung bei unsachgemäßer Montage. Das Befestigungsmaterial für Standard-Keramikwaschtisch ist inklusive (2 Stockschrauben M10x120 inkl. Dübel für massive Steinwand. Bei anderen Wandbeschaffenheiten muss der Dübel entsprechend angepasst werden).

We recommend installation only by a qualified fitter / installer. No liability for improper installation. The mounting material for the standard ceramic washbasin is included (2 screws M10x120 including dowels for solid stone wall, for other wall conditions the dowel must be adapted accordingly).

Schränke/cabinets 3400

Frontfarben/front colours

Dickkante/thick edge



Korpusfarben/basic shell colours

PG 1



Aufdopplungsseiten/side panels 10 mm



Griffe/handles



⊕—⊕ = Bohrabstand/hole spacing

Beleuchtung / lighting



Die Steckdose / Powerbox ist auch in Ausführung für die Schweiz / Frankreich erhältlich. Bitte Mehrpreis beachten (siehe Zubehör Seite 1).
The power socket is also available for Switzerland / France. Please note extra charge (see accessories page 1).

Konzept/concept 3400

Spiegelschrank/ <i>mirror cabinet</i>	Waschtisch/ <i>washbasin</i>	Waschtischunter- schrank/ <i>washbasin cabinet</i>	Farben Front/Korpus <i>Colours front/carcase</i> Griffe/ <i>handles</i>	Aufdopplungsseiten/ <i>side panels</i> 10 mm
--	---------------------------------	--	--	--

Breite 80 cm / width 80 cm



Spiegelschrank 3 Türen/
mirror cabinet 3 doors
SLEB8

Spiegelschrank 3 Türen
inkl. Aufdopplung/
mirror cabinet 3 doors
inkl. *side panels*
SLEB8A



Keramik Waschtisch/
ceramic washbasin
KWSOF8



Unterschrank 1 Auszug, 1 Blende/
base cabinet 1 extension, 1 cover
WKDBS7

Unterschrank 1 Auszug, 1 Blende
inkl. Aufdopplung/
base cabinet 1 extension, 1 cover
inkl. *side panels*
WKDBS7A



Unterschrank 2 Auszüge/
base cabinet 2 extensions
WKDSA7

Unterschrank 2 Auszüge
inkl. Aufdopplung/
base cabinet 2 extensions
inkl. *side panels*
WKDSA7A

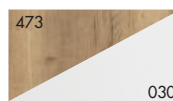

Weiß
Seidenglanz/
Silk Gloss
White



Anthrazit
Matt/
Anthracite



Eiche Struktur
Nachbildung
Oak Structure
Finish

Breite 100 cm / width 100 cm



Spiegelschrank 3 Türen/
mirror cabinet 3 doors
SLEB10

Spiegelschrank 3 Türen
inkl. Aufdopplung/
mirror cabinet 3 doors
inkl. *side panels*
SLEB10A



Keramik Waschtisch/
ceramic washbasin
KWSOF10



Unterschrank 1 Auszug, 1 Blende/
base cabinet 1 extension, 1 cover
WKDBS9

Unterschrank 1 Auszug, 1 Blende
inkl. Aufdopplung/
base cabinet 1 extension, 1 cover
inkl. *side panels*
WKDBS9A



Unterschrank 2 Auszüge/
base cabinet 2 extensions
WKDSA9

Unterschrank 2 Auszüge
inkl. Aufdopplung/
base cabinet 2 extensions
inkl. *side panels*
WKDSA9A

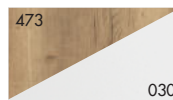

Weiß
Seidenglanz/
Silk Gloss
White



Anthrazit
Matt/
Anthracite











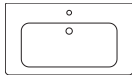

Eiche Struktur
Nachbildung
Oak Structure
Finish

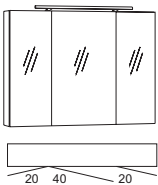

Beschreibung Description	Maße in cm Dimensions in cm			Artikel-Nr. Article no.	Türanschlag Door stop	Identnummer ID number
	B/W	H	T/D			
 <p>Kombination 80 cm bestehend aus: Spiegelschrank, 3 Spiegeltüren Keramik Waschtisch Waschtisch-Unterschrank, 1 feste Blende, 1 Schubkasten Highboard inkl. Abdeckplatte 16 mm Hochschrank</p> <p><i>combination 80 cm width consisting of: mirror cabinet, 3 mirror doors ceramic washbasin washbasin base cabinet, 1 fixed cover, 1 drawer high cabinet incl. top 16 mm tower cabinet</i></p>				SLEB8 KWSOF8 WKDBS7 HBST4F HTST4	 	PG1 Dickkante/ <i>thick edge</i> 3730
 <p>Kombination 80 cm bestehend aus: Spiegelschrank, 3 Spiegeltüren Keramik Waschtisch Waschtisch-Unterschrank, 1 Schubkasten, 1 Auszug Mittelschrank inkl. Abdeckplatte 16 mm Mittelschrank inkl. Abdeckplatte 16 mm</p> <p><i>combination 80 cm width consisting of: mirror cabinet, 3 mirror doors ceramic washbasin washbasin base cabinet, 1 drawer, 1 extension medium cabinet incl. top 16 mm medium cabinet incl. top 16 mm</i></p>				SLEB8 KWSOF8 WKDSA7 MTST4F MTST4F	 	4349
 <p>Kombination 82 cm bestehend aus: Spiegelschrank inkl. Aufdopplung 10 mm, 3 Spiegeltüren Keramik Waschtisch Waschtisch-Unterschrank mit Aufdopplung 10 mm, 1 feste Blende, 1 Schubkasten Mittelschrank inkl. Abdeckplatte und Aufdopplung 10 mm</p> <p><i>combination 82 cm width consisting of: mirror cabinet incl. side panels 10 mm, 3 mirror doors ceramic washbasin washbasin base cabinet incl. side panels 10 mm, 1 fixed cover, 1 drawer medium cabinet incl. side panels, incl. top 10 mm</i></p>				SLEB8A KWSOF8 WKDBS7A MTST4A	 	3425
 <p>Kombination 102 cm bestehend aus: Spiegelschrank inkl. Aufdopplung 10 mm, 3 Spiegeltüren Keramik Waschtisch Waschtisch-Unterschrank mit Aufdopplung 10 mm, 1 Schubkasten, 1 Auszug Highboard inkl. Aufdopplung 10 mm Highboard inkl. Aufdopplung 10 mm Mittelschrank inkl. Aufdopplung, inkl. Abdeckplatte 10 mm</p> <p><i>combination 102 cm width consisting of: mirror cabinet incl. side panels 10 mm, 3 mirror doors ceramic washbasin washbasin base cabinet incl. side panels 10 mm, 1 drawer, 1 extension high cabinet incl. side panels 10 mm high cabinet incl. side panels 10 mm medium cabinet incl. side panels, incl. top 10 mm</i></p>				SLEB10A KWSOF10 WKDSA9A HBST4A HBST4A MTST4A	 	5978

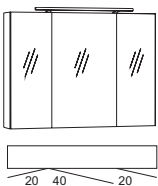









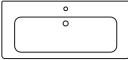

3400 »80 cm Keramik/ceramic«

	Beschreibung Description	Maße in cm Dimensions in cm			Artikel-Nr. Article no.	Türanschlag Door stop	Identnummer ID number
		B/W	H	T/D			
	Keramik-Waschtisch inkl. Überlauf und Befestigungsmaterial <i>ceramic washbasin incl. overflow and fastener</i>	80	3,0	45,5	KWSOF8		479
							PG1 Dickkante/thick edge
	Waschtisch-Unterschrank 1 feste Blende, 1 Schubkasten <i>washbasin base cabinet 1 fixed cover, 1 drawer</i>	75,0	37,6	43,8	WKDBS7		527
	Waschtisch-Unterschrank inklusive Aufdopplungsseiten 10 mm, 1 feste Blende, 1 Schubkasten <i>washbasin base cabinet inclusive side panels 10 mm, 1 fixed cover, 1 drawer</i>	77,0	37,6	43,8	WKDBS7A		666
	Waschtisch-Unterschrank 1 Schubkasten, 1 Auszug <i>washbasin base cabinet 1 drawer, 1 extension</i>	75,0	48,8	43,8	WKDSA7		862
	Waschtisch-Unterschrank inklusive Aufdopplungsseiten 10 mm, 1 Schubkasten, 1 Auszug <i>washbasin base cabinet inclusive side panels 10 mm, 1 drawer, 1 extension</i>	77,0	48,8	43,8	WKDSA7A		1015
	Spiegelschrank, 3 Spiegeltüren 6 Glaseinlegeböden, LED-Aufbauleuchte DE60, 8,0 W 6000 Kelvin, inkl. Schalter/Steckdose EEK A-A++ <i>mirror cabinet, 3 mirror doors 6 glass boards, LED lighting DE60 8,0 W, 6000 Kelvin incl. switch/socket EEC A-A++</i>	80,0	68,2	13,4	SLEB8		862
	Spiegelschrank inklusive Aufdopplungsseiten 10 mm, 3 Spiegeltüren, 6 Glaseinlegeböden, LED-Aufbauleuchte DE60, 8,0 W 6000 Kelvin, inkl. Schalter/Steckdose EEK A-A++ <i>mirror cabinet inclusive side panels 10 mm, 3 mirror doors, 6 glass boards, LED lighting DE60, 8,0 W, 6000 Kelvin incl. switch/socket EEC A-A++</i>	82,0	68,2	13,4	SLEB8A		987

EEK/EEC=Energieeffizienzklasse/energy efficiency category

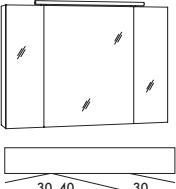
 Farben der Aufdopplungsseiten unbedingt mit angeben, Übersicht siehe Seite 2. Please indicate side panel colours, overview see page 2.

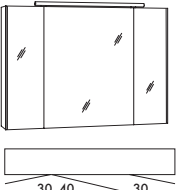
3400 »100 cm Keramik/ceramic«







Beschreibung Description	Maße in cm Dimensions in cm			Artikel-Nr. Article no.	Türanschlag Door stop	Identnummer ID number
	B/W	H	T/D			
 <p>Keramik-Waschtisch inkl. Überlauf und Befestigungsmaterial</p> <p><i>ceramic washbasin incl. overflow and fastener</i></p>	101,0	3,0	45,5	KWSOF10		551
						PG1 Dickkante/ <i>thick edge</i>
 <p>Waschtisch-Unterschrank 1 feste Blende, 1 Schubkasten</p> <p><i>washbasin base cabinet 1 fixed cover, 1 drawer</i></p>	95,0	37,6	43,8	WKDBS9		646
  <p>Waschtisch-Unterschrank inklusive Aufdopplungsseiten 10 mm, 1 feste Blende, 1 Schubkasten</p> <p><i>washbasin base cabinet inclusive side panels 10 mm 1 fixed cover, 1 drawer</i></p>	97,0	37,6	43,8	WKDBS9A		785
 <p>Waschtisch-Unterschrank 1 Schubkasten, 1 Auszug</p> <p><i>washbasin base cabinet 1 drawer, 1 extension</i></p>	95,0	48,8	43,8	WKDSA9		982
  <p>Waschtisch-Unterschrank inklusive Aufdopplungsseiten 10 mm, 1 Schubkasten, 1 Auszug</p> <p><i>washbasin base cabinet inclusive side panels 10 mm, 1 drawer, 1 extension</i></p>	97,0	48,8	43,8	WKDSA9A		1135
 <p>Spiegelschrank, 3 Spiegeltüren 6 Glaseinlegeböden, LED-Aufbauleuchte DE60, 8,0 W 6000 Kelvin, inkl. Schalter/Steckdose EEK A-A++</p> <p><i>mirror cabinet, 3 mirror doors 6 glass boards, LED lighting DE60 8,0 W, 6000 Kelvin incl. switch/socket EEC A-A++</i></p>	100	68,2	13,4	SLEB10		958
  <p>Spiegelschrank, inklusive Aufdopplungsseiten 10 mm, 3 Spiegeltüren, 6 Glaseinlegeböden, LED-Aufbauleuchte DE60, 8,0 W 6000 Kelvin, inkl. Schalter/Steckdose EEK A-A++</p> <p><i>mirror cabinet, inclusive side panels 10 mm, 3 mirror doors, 6 glass boards, LED lighting DE60, 8,0 W, 6000 Kelvin incl. switch/socket EEC A-A++</i></p>	102	68,2	13,4	SLEB10A		1083

EEK/EEC=Energieeffizienzklasse/energy efficiency category

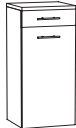







 Farben der Aufdopplungsseiten unbedingt mit angeben, Übersicht siehe Seite 2. Please indicate side panel colours, overview see page 2.

3400 »Beistellschränke/ side cabinets«





Beschreibung Description	Maße in cm Dimensions in cm			Artikel-Nr. Article no.	Türanschlag Door stop	Identnummer ID number
	B/W	H	T/D			

							PG1 Dickkante/thick edge
	Highboard inklusive Abdeckplatte 16 mm 1 Tür, 1 Schubkasten 2 Glaseinlegeböden <i>high cabinet inclusive top 16 mm 1 door, 1 drawer 2 glass boards</i>	40,0	91,0	34,8	HBST4FL HBST4FR	Links/left Rechts/right	809
i 	Highboard inklusive Aufdopplungsseiten und Abdeckplatte 10 mm 1 Tür, 1 Schubkasten 2 Glaseinlegeböden <i>high cabinet inclusive side panels and top 10 mm 1 door, 1 drawer 2 glass boards</i>	42,0	90,4	34,8	HBST4AL HBST4AR	Links/left Rechts/right	958
	Mittelschrank inkl. Abdeckplatte 16 mm 2 Türen, 1 Schubkasten 3 Glaseinlegeböden <i>medium cabinet inclusive top 16 mm 2 doors, 1 drawer 3 glass boards</i>	40,0	148,6	34,8	MTST4FL MTST4FR	Links/left Rechts/right	1073
i 	Mittelschrank inklusive Aufdopplungsseiten und Abdeckplatte 10 mm 2 Türen, 1 Schubkasten 3 Glaseinlegeböden <i>medium cabinet inclusive side panels and top 10 mm 2 doors, 1 drawer 3 glass boards</i>	42,0	148,0	34,8	MTST4AL MTST4AR	Links/left Rechts/right	1293
	Hochschrank 2 Türen, 1 Schubkasten 3 Glaseinlegeböden <i>tower cabinet 2 doors / 1 drawer 3 glass boards</i>	40,0	178,8	34,8	HTST4L HTST4R	Links/left Rechts/right	1053
i 	Hochschrank inklusive Aufdopplungsseiten und Abdeckplatte 10 mm, 2 Türen, 1 Schubkasten 3 Glaseinlegeböden <i>tower cabinet inclusive side panels and top 10 mm 2 doors / 1 drawer 3 glass boards</i>	42,0	179,8	34,8	HTST4AL HTST4AR	Links/left Rechts/right	1437

i Farben unbedingt mit angeben, Übersicht siehe Seite 2. Please indicate colours, overview see page 2.

Beschreibung Description	Maße in cm Dimensions in cm			Artikel-Nr. Article no.	Türanschlag Door stop	Identnummer ID number
	B/W	H	T/D			
 Handtuchhalter 1-armig (Befestigung am Schrank) <i>towel rail 1-arm (fastening on the cabinet)</i>	5	1	33	HHF133		85
 Handtuchhalter 1-armig (Befestigung am Schrank) <i>towel rail 1-arm (fastening on the cabinet)</i>	5	1	33	HHF133S		129
 Handtuchhalter 1-armig (Befestigung am Schrank) ausziehbar <i>towel rail 1-arm (fastening on the cabinet) pull out</i>	7,5	4	32,5/ 50	HH133		112
 Handtuchhalter 2-armig (Befestigung am Schrank) ausziehbar <i>towel rail 2-arms (fastening on the cabinet) pull out</i>	10,5	4	32,5/ 50	HH233		141
 Handtuchhalter verchromt (Befestigung am Schrank) <i>chromed towel rail (fastening on the cabinet)</i>	5	2,5	40	RHH		189
 Spiegelschrank-Unterbauleuchte 5,8 W LED EEK A–A++ (für Spiegelschrank ab 60 cm Breite), 6000 Kelvin Beleuchtung kann unter Spiegel- schränken und unter Regalen verbaut werden. <i>base lighting for mirror cabinet 5,8 W LED EEC A–A++ (for mirror cabinet ex 60 cm width), 6000 Kelvin Lighting can be installed under mirror cabinets and under shelves.</i>	57			WTBP60		289
 Spiegelschrank-Unterbauleuchte 3,4 W LED EEK A–A++ (für Spiegel- schrank ab 80 cm Breite) 6000 Kelvin Beleuchtung kann nur unter Spiegel- schränke und nicht unter Regale verbaut werden. <i>base lighting for mirror cabinet 3,4 W LED EEC A–A++ (for mirror cabinet ex 80 cm width) 6000 Kelvin Lighting only can be installed under mirror cabinets and not under shelves.</i>	70			WTB70		265
 Waschtischunterschrankbeleuchtung 6,7 W LED, 4000/4500/6000 Kelvin umschaltbar in 3 Lichtfarben , EEK A–A++ inkl. Schalter, für Unterschrank ab 80 cm Breite <i>base lighting for washbasin cabinet 6,7 W LED, 4000/4500/6000 Kelvin 3 switchable luminous colours EEC A–A++, incl. switch, for base cabinet ex 80 cm width</i>	70	2	1,5	WUTB72		307

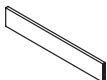
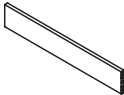
EEK/EEC=Energieeffizienzklasse/energy efficiency category

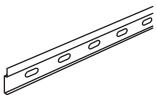
Beschreibung Description	Maße in cm Dimensions in cm			Artikel-Nr. Article no.	Türanschlag Door stop	Identnummer ID number
	B/W	H	T/D			
 <p>Schubkasteneinsatz (Kunststoff) für oberen Auszug vom WT-Unterschrank <i>drawer insert part (plastic) for top drawer from base cabinet</i></p>	33,7	4,3	28	SMBEG3		59
 <p>Schubkasteneinsatz (Kunststoff) für Schubkasten 40 cm B: 40 cm / T: 30 cm für Beistellschränke <i>drawer insert part (plastic) for drawer 40 cm w: 40cm / d: 30 cm for side cabinets</i></p>	30,9	4,5	28	SEG4		66
 <p>Inneneinteilung für 75 cm Auszug <i>internal subdivision for 75 cm extension</i></p>	73	6	1,1	IEG75		139
 <p>Inneneinteilung für 95 cm Auszug <i>internal subdivision for 95 cm extension</i></p>	93	6	1,1	IEG95		159
 <p>Designsiphon <i>design siphon</i></p>				DS		229
 <p>Raumsparsiphon <i>basin siphon</i></p>				RSPAR-4		86
 <p>Montageschiene inkl. Befestigungsmaterial <i>mounting rail incl. fastening material</i></p>	210			MS210		125

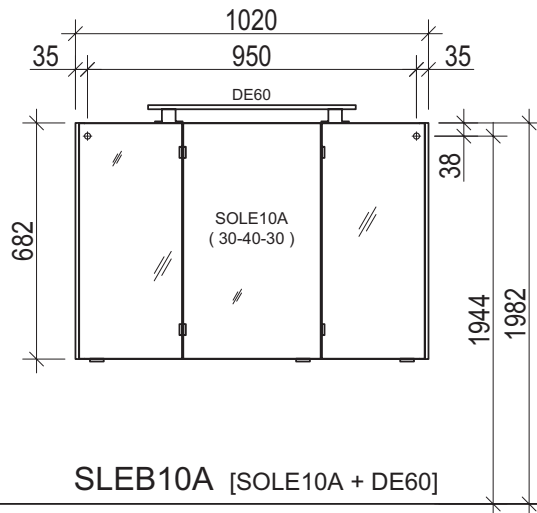
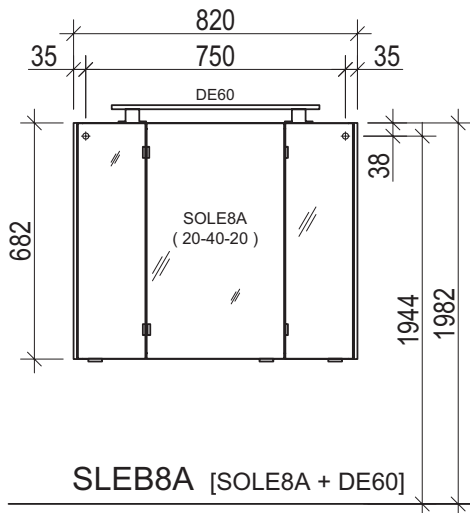
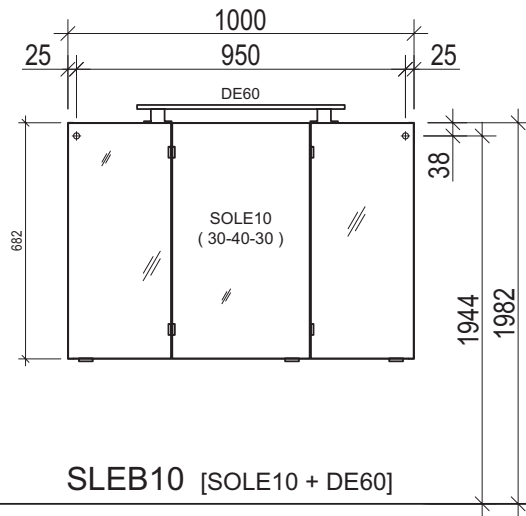
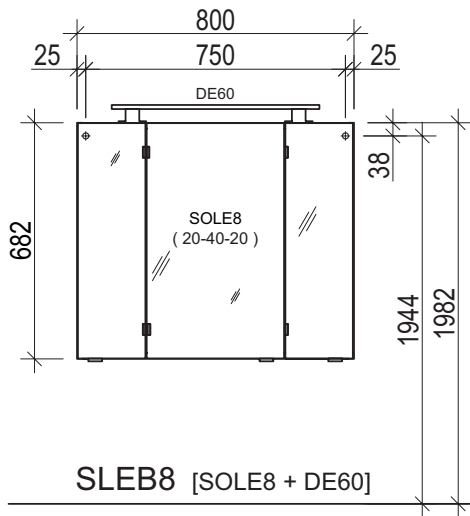

! Achtung: Die Montage muss durch fachkundige Personen erfolgen. Der Untergrund zur Wandbefestigung ist vor Montage zu prüfen. Bitte wählen Sie entsprechend das geeignete Befestigungsmaterial. Fehlerhafte Montagen können das Möbel beschädigen oder dessen Funktion dauerhaft beeinträchtigen. Für Sach- und Personenschäden übernehmen wir im Falle einer unsachgemäßen Montage keine Haftung.

Attention: Assembly must be carried out by skilled personnel. The subsurface for the wall mounting must be checked before assembly. Please select a suitable mounting material. Faulty assembly can damage furniture or permanently impair its function. We will not be held responsible for damage to material or persons in the case of improper assembly.

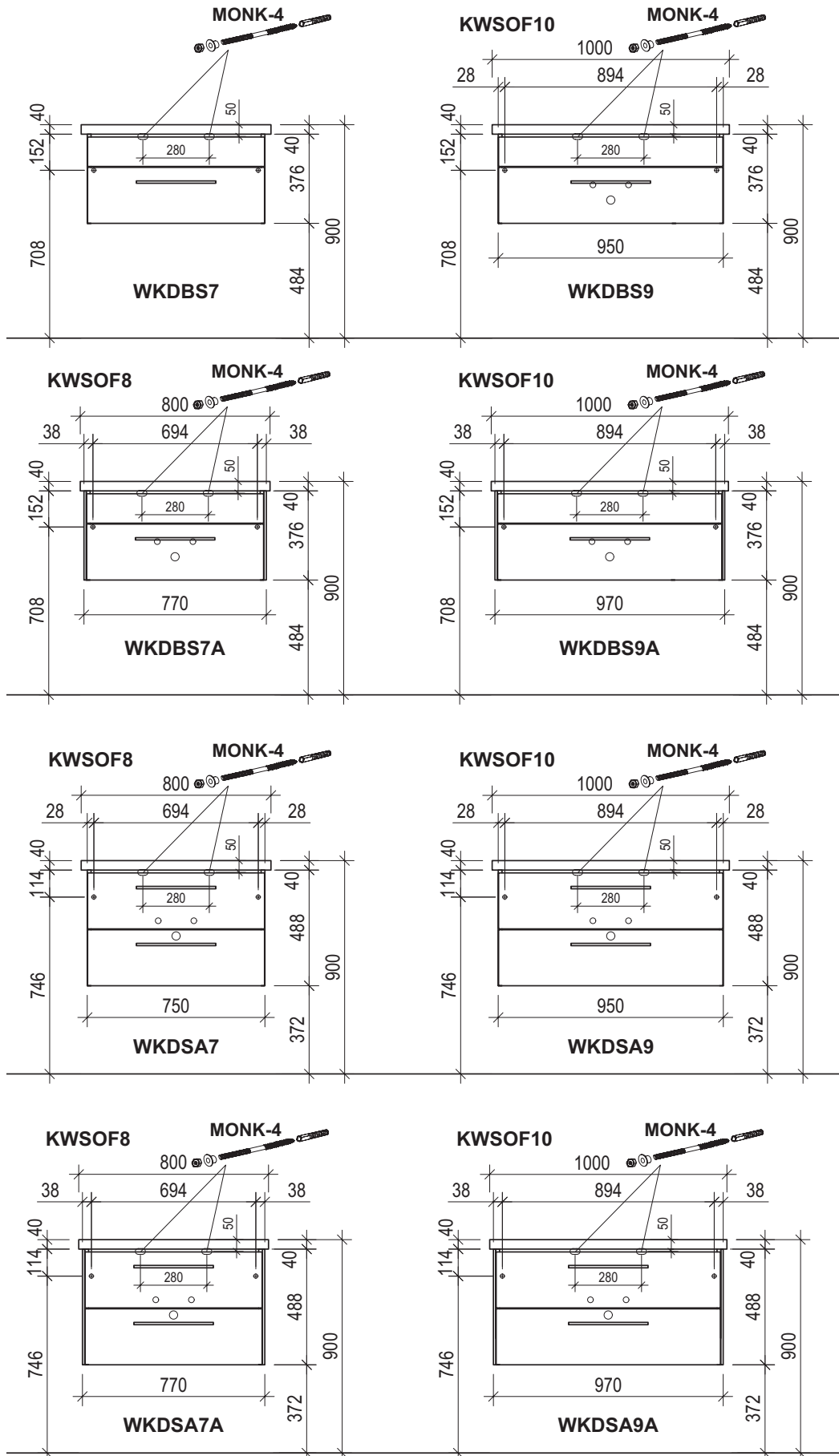

! Achtung: Die Montage muss durch fachkundige Personen erfolgen. Der Untergrund zur Wandbefestigung ist vor Montage zu prüfen. Bitte wählen Sie entsprechend das geeignete Befestigungsmaterial. Fehlerhafte Montagen können das Möbel beschädigen oder dessen Funktion dauerhaft beeinträchtigen. Für Sach- und Personenschäden übernehmen wir im Falle einer unsachgemäßen Montage keine Haftung.
 Attention: Assembly must be carried out by skilled personnel. The subsurface for the wall mounting must be checked before assembly. Please select a suitable mounting material. Faulty assembly can damage furniture or permanently impair its function. We will not be held responsible for damage to material or persons in the case of improper assembly.

HBST4W

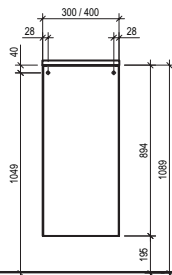

MTST4W

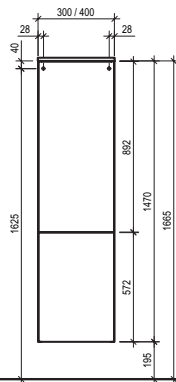

HTST4W

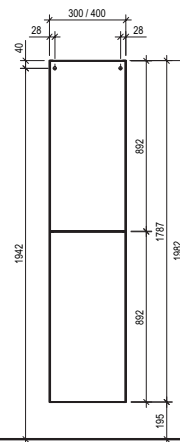

! Achtung: Die Montage muss durch fachkundige Personen erfolgen. Der Untergrund zur Wandbefestigung ist vor Montage zu prüfen. Bitte wählen Sie entsprechend das geeignete Befestigungsmaterial. Fehlerhafte Montagen können das Möbel beschädigen oder dessen Funktion dauerhaft beeinträchtigen. Für Sach- und Personenschäden übernehmen wir im Falle einer unsachgemäßen Montage keine Haftung.
 Attention: Assembly must be carried out by skilled personnel. The subsurface for the wall mounting must be checked before assembly. Please select a suitable mounting material. Faulty assembly can damage furniture or permanently impair its function. We will not be held responsible for damage to material or persons in the case of improper assembly.