

Möbel LETZ

Finden und Wohlfühlen



Typenplan

3390 von Marlin - Badezimmer anthrazit

Wichtiger Hinweis für Sie

Etwaige Hinweise des Herstellers in dieser Produktinformation, die sich auf die Gewährleistung beziehen, haben für Sie keinerlei Bindungswirkung und können von Ihnen ignoriert werden. Ihre gesetzlichen Gewährleistungsrechte als Verbraucher uns gegenüber, als Ihrem Verkäufer, werden dadurch in keiner Weise berührt oder eingeschränkt. Sie können sich wegen aller Mängel jederzeit an uns wenden. Darüber hinaus gehende Herstellergarantien bleiben natürlich unberührt. Dieser Artikel wird hergestellt von MARLIN Badmöbel, Jaka-Str. 3, 32351 Stemwede, Deutschland, marlin@marlinbad.de

Möbel Letz GmbH
Am Gewerbepark 11
06895 Zahna-Elster

Tel.: 035383 - 6018 50

Fax.: 035383 - 6018 17

Piktogramme/pictograms



Mineralmarmor Waschtisch
Marble minerals washbasin



LED Lichtfarbe kalt
LED colour temperature cold



LED mit Bewegungssensor
LED with motion sensor



Keramik Waschtisch
Ceramic washbasin



LED Lichtfarbe warm
LED colour temperature warm



LED mit Sensorschalter
LED with sensor switch



Glas Waschtisch
Glass washbasin



LED Lichtfarbe regelbar,
Helligkeit dimmbar
LED colour temperature adjust-
able, brightness dimmable



LED Lichtfarbe schaltbar bzw. regelbar
LED colour temperature adjustable

Mineralmarmor Waschbecken weiß alpin Glanz (FG69) Marble minerals on-top washbasin gloss alpine white (FG69)

»Inga«

≈ Beckenmaße in cm (BxHxT)
basin dimensions in cm (WxHxD)

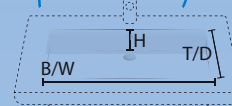

MWING6 | 57 x 12 x 31 cm



Detail

Keramik Waschbecken weiß alpin Glanz (FGK) Ceramic on-top washbasin gloss alpine white (FGK)

»Bella«

≈ Beckenmaße in cm (BxHxT)
basin dimensions in cm (WxHxD)

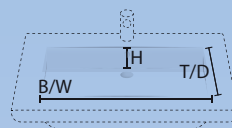

KWBEL7 | 69 x 11 x 29 cm

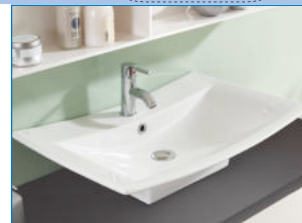

Detail

»Poco«



KWPOC55 | 50 x 11 x 30 cm



Detail

Schränke/cabinets 3390





Frontfarben/front colours

Dickkante/thick edge

 286	Weiß Seidenglanz <i>Silk Gloss White</i> FGE_	 284	Anthrazit Seidenglanz <i>Silk Gloss Anthracite</i> FGA_
 490	Kastanie Graphit Nachbildung <i>Graphite Chestnut Finish</i> FGC_	 488	Robinie Dunkel Nachbildung <i>Robinia Dark Finish</i> FGJ_
		 473	Eiche Struktur Nachbildung <i>Oak Structure Finish</i> FGM_

Korpusfarben/basic shell colours

PG 1

 286	Weiß Seidenglanz <i>Silk Gloss White</i> E/FG86	 284	Anthrazit Seidenglanz <i>Silk Gloss Anthracite</i> A/FG84
 490	Kastanie Graphit Nachbildung <i>Graphite Chestnut Finish</i> C/FG45	 488	Robinie Dunkel Nachbildung <i>Robinia Dark Finish</i> J/FG58
		 473	Eiche Struktur Nachbildung <i>Oak Structure Finish</i> M/FG55

Waschtischplattenfarben/washbasin plate colours

 Polaris <i>Polaris</i> FG96	 Prado Achatgrau <i>Prado Achatgrey</i> FG97	 Eiche Struktur Nachbildung <i>Oak Structure Finish</i> FG55
---	--	---

Regalfarben/ shelf colours

287



Weiß Seidenglanz
Silk Gloss White
FG86

285



Anthrazit Seidenglanz
Silk Gloss Anthracite
FG84

491

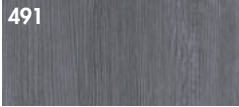

Kastanie Graphit Nachbildung
Graphite Chestnut Finish
FG45

489

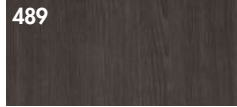

Robinie Dunkel Nachbildung
Robinia Dark Finish
FG58

474



Eiche Struktur Nachbildung
Oak Structure Finish
FG55

Griffleiste/handle bar



Aluminium Matt
Matt aluminium

Beleuchtung / lighting



Aufbauleuchte LED
Top light LED

Lichtfarbe Tageslicht (Kalt)

Luminous colour natural light (cold)



AW80, AWP90,
AW100, AW120,
AWP120





Seitlich und oben LED Beleuchtung
lateral and top LED lighting







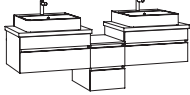





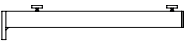

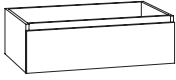

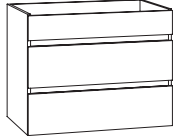

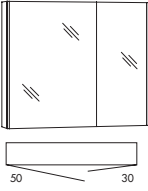

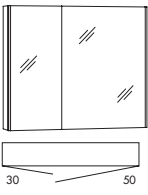

Die Steckdose / Powerbox ist auch in Ausführung für die Schweiz / Frankreich erhältlich. Bitte Mehrpreis beachten (siehe Zubehör Seite 1).
The power socket is also available for Switzerland / France. Please note extra charge (see accessories page 1).

3390 »Beispiel-Kombinationen/ example-combinations«



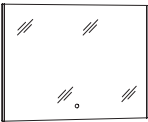





Beschreibung Description	Maße in cm Dimensions in cm			Artikel-Nr. Article no.	Türanschlag Door stop	Identnummer ID number
	B/W	H	T/D			

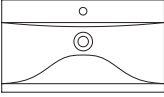

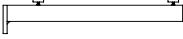



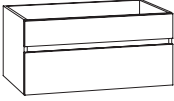

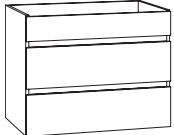

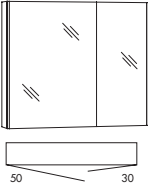

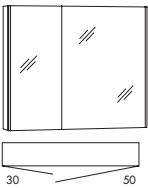

						PG1 Dickkante/ thick edge	
 	Kombination 200 cm bestehend aus: 2x Spiegelschrank, 3 Spiegeltüren 2x Regal seitlich, 20 cm 2x Aufsatz-Mineralmarmor-Washbecken Inga 2x Waschtischplatte 2x Waschtischkonsole 2x Waschtisch-Unterschrank Unterschrank inkl. Abdeckplatte, 40 cm			SDU8 REB20 MWING6 WTP18M WK GWPWSS7 GUWAA4F		 	10769
	combination 200 cm width consisting of: 2x mirror cabinet, 3 mirror doors 2x shelf lateral, 20 cm 2x on-top marble minerals washbasin Inga 2x washbasin plate 2x washbasin mounting bracket 2x washbasin base cabinet base cabinet incl. top, 40 cm						

Beschreibung Description	Maße in cm Dimensions in cm			Artikel-Nr. Article no.	Türanschlag Door stop	Identnummer ID number
	B/W	H	T/D			
 <p>Aufsatz-Mineralmarmor-Waschbecken inkl. Überlaufgarnitur und Montageset MONK-4</p> <p><i>on-top marble minerals washbasin incl. overflow and mounting-set MONK-4</i></p>	60,0	12,0	45,0	MWING6		946
						
 <p>Waschtischkonsole Stahlrohr 4 x 4 cm, erforderlich</p> <p><i>washbasin mounting bracket steel 4 x 4 cm, required</i></p>	4,0	4,0	39,2	WK		134
						PG1 Dickkante/thick edge
 <p>Waschtischplatte ohne Ausfräsung</p> <p><i>Washbasin plate without notch</i></p>	80,0	4,0	48,5	WTP8		408
 <p>Waschtischplatte inkl. Ausfräsung mittig</p> <p><i>Washbasin plate with central notch</i></p>	80,0	4,0	48,5	WTPI8M		443
 <p>Waschtisch-Unterschrank 1 Schubkasten</p> <p><i>washbasin base cabinet 1 drawer</i></p>	77,0	23,8	47,8	GWPWS7		766
 <p>Waschtisch-Unterschrank 2 Schubkästen</p> <p><i>washbasin base cabinet 2 drawers</i></p>	77,0	36,6	47,8	GWPWS7		1053
 <p>Waschtisch-Unterschrank 1 Schubkasten, 1 Auszug</p> <p><i>washbasin base cabinet 1 drawer, 1 extension</i></p>	77,0	47,8	47,8	GWPWSA7		1197
 <p>Waschtisch-Unterschrank 2 Schubkästen, 1 Auszug</p> <p><i>washbasin base cabinet 2 drawers, 1 extension</i></p>	77,0	60,6	47,8	GWPWSA7		1437



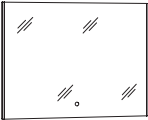





Beschreibung Description	Maße in cm Dimensions in cm			Artikel-Nr. Article no.	Türanschlag Door stop	Identnummer ID number
	B/W	H	T/D			
 <p>Spiegelschrank, 2 vollflächig verspiegelte Türen, 2 Glaseinlegeböden, seitliche LED-Beleuchtung 12,4 W, 6000 Kelvin inkl. Schalter/Steckdose, EEK A-A++</p> <p><i>mirror cabinet, 2 full mirrored doors 2 glass boards, lateral LED-lighting 12,4 W, 6000 Kelvin incl. switch/socket, EEC A-A++</i></p>	80,0	68,2	17,6	SADA8L		1552
 <p>Spiegelschrank, 2 vollflächig verspiegelte Türen, 2 Glaseinlegeböden, seitliche LED-Beleuchtung 12,4 W, 6000 Kelvin inkl. Schalter/Steckdose, EEK A-A++</p> <p><i>mirror cabinet, 2 full mirrored doors 2 glass boards, lateral LED-lighting 12,4 W, 6000 Kelvin incl. switch/socket, EEC A-A++</i></p>	80,0	68,2	17,6	SADA8R		1552
 <p>LED-Aufbauleuchte für Spiegelschrank mit LED-Mini-Stecker, 10,8 W, 6000 Kelvin, ohne Schalter, EEK A-A++</p> <p><i>LED lighting for mirror cabinet with LED-mini-plug, 10,8 W, 6000 Kelvin, without switch, EEC A-A++</i></p>	80	2,4	20	AW80		423
 <p>Spiegelschrank, 3 Spiegeltüren davon 2 trapezförmig angeordnet, 6 Glaseinlegeböden, seitlich und oben LED-Beleuchtung, 19,8 W, 6000 Kelvin, inkl. Schalter/Steckdose, EEK A-A++</p> <p><i>mirror cabinet, 3 mirror doors, 2 of them are arranged in a trapeze, 6 glass shelves, lateral and top LED lighting 19,8 W, 6000 Kelvin incl. switch/socket, EEC A-A++</i></p>	80	68,2	17,5	SDU8		1963
 <p>Spiegelschrank, 3 Spiegeltüren davon 2 trapezförmig angeordnet, 6 Glaseinlegeböden, seitlich und oben LED-Beleuchtung, 20,8 W, 6000 Kelvin, inkl. Schalter/Steckdose, EEK A-A++</p> <p><i>mirror cabinet, 3 mirror doors, 2 of them are arranged in a trapeze, 6 glass shelves, lateral and top LED lighting 20,8 W, 6000 Kelvin incl. switch/socket, EEC A-A++</i></p>	90	68,2	17,5	SDU9		2035
 <p>Spiegelpaneel, Sensorschalter, seitliche LED-Beleuchtung 2x 6,2 W 6000 Kelvin EEK A-A++</p> <p><i>mirror panel, sensor switch lateral LED-lighting 2x 6,2 W, 6000 Kelvin EEC A-A++</i></p>	90	68,2	2,8	SPBSA9	 	1074
 <p>LED-Aufbauleuchte für Spiegelpaneel mit LED-Mini-Stecker, 12,2 W, 6000 Kelvin, ohne Schalter, EEK A-A++</p> <p><i>LED-lighting for mirror panel with LED-mini-plug, 12,2 W, 6000 Kelvin, without switch, EEC A-A++</i></p>	90	2,4	10	AWP90		348

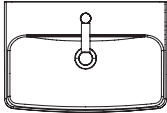

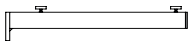





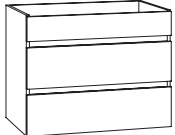

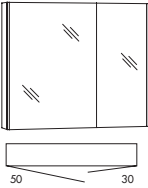

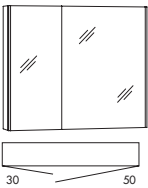

EEK/EEC=Energieeffizienzklasse/energy efficiency category

Beschreibung Description	Maße in cm Dimensions in cm			Artikel-Nr. Article no.	Türanschlag Door stop	Identnummer ID number
	B/W	H	T/D			
 <p>Aufsatz-Keramik-Washbecken inkl. Überlauf</p> <p><i>on-top ceramic washbasin incl. overflow</i></p>	71,0	16,0	44,5	KWBEL7		801
						
 <p>Waschtischkonsole Stahlrohr 4 x 4 cm, erforderlich</p> <p><i>washbasin mounting bracket steel 4 x 4 cm, required</i></p>	4,0	4,0	39,2	WK		134
						PG1 Dickkante/ <i>thick edge</i>
 <p>Waschtischplatte ohne Ausfräsung</p> <p><i>Washbasin plate without notch</i></p>	80,0	4,0	48,5	WTP8		408
 <p>Waschtischplatte inkl. Ausfräsung mittig</p> <p><i>Washbasin plate with central notch</i></p>	80,0	4,0	48,5	WTPB8M		443
 <p>Waschtisch-Unterschrank 1 Schubkasten</p> <p><i>washbasin base cabinet 1 drawer</i></p>	77,0	23,8	47,8	GWPWS7		766
 <p>Waschtisch-Unterschrank 2 Schubkästen</p> <p><i>washbasin base cabinet 2 drawers</i></p>	77,0	36,6	47,8	GWPWSS7		1053
 <p>Waschtisch-Unterschrank 1 Schubkasten, 1 Auszug</p> <p><i>washbasin base cabinet 1 drawer, 1 extension</i></p>	77,0	47,8	47,8	GWPWSA7		1197
 <p>Waschtisch-Unterschrank 2 Schubkästen, 1 Auszug</p> <p><i>washbasin base cabinet 2 drawers, 1 extension</i></p>	77,0	60,6	47,8	GWPWSSA7		1437



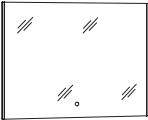





Beschreibung Description	Maße in cm Dimensions in cm			Artikel-Nr. Article no.	Türanschlag Door stop	Identnummer ID number
	B/W	H	T/D			
 <p>Spiegelschrank, 2 vollflächig verspiegelte Türen, 2 Glaseinlegeböden, seitliche LED-Beleuchtung 12,4 W, 6000 Kelvin inkl. Schalter/Steckdose, EEC A-A++</p> <p><i>mirror cabinet, 2 full mirrored doors 2 glass boards, lateral LED-lighting 12,4 W, 6000 Kelvin incl. switch/socket, EEC A-A++</i></p>	80,0	68,2	17,6	SADA8L		1552
 <p>Spiegelschrank, 2 vollflächig verspiegelte Türen, 2 Glaseinlegeböden, seitliche LED-Beleuchtung 12,4 W, 6000 Kelvin inkl. Schalter/Steckdose, EEC A-A++</p> <p><i>mirror cabinet, 2 full mirrored doors 2 glass boards, lateral LED-lighting 12,4 W, 6000 Kelvin incl. switch/socket, EEC A-A++</i></p>	80,0	68,2	17,6	SADA8R		1552
 <p>LED-Aufbauleuchte für Spiegelschrank mit LED-Mini-Stecker, 10,8 W, 6000 Kelvin, ohne Schalter, EEC A-A++</p> <p><i>LED lighting for mirror cabinet with LED-mini-plug, 10,8 W, 6000 Kelvin, without switch, EEC A-A++</i></p>	80	2,4	20	AW80		423
 <p>Spiegelschrank, 3 Spiegeltüren davon 2 trapezförmig angeordnet, 6 Glaseinlegeböden, seitlich und oben LED-Beleuchtung, 19,8 W, 6000 Kelvin, inkl. Schalter/Steckdose, EEC A-A++</p> <p><i>mirror cabinet, 3 mirror doors, 2 of them are arranged in a trapeze, 6 glass shelves, lateral and top LED lighting 19,8 W, 6000 Kelvin incl. switch/socket, EEC A-A++</i></p>	80	68,2	17,5	SDU8		1963
 <p>Spiegelschrank, 3 Spiegeltüren davon 2 trapezförmig angeordnet, 6 Glaseinlegeböden, seitlich und oben LED-Beleuchtung, 20,8 W, 6000 Kelvin, inkl. Schalter/Steckdose, EEC A-A++</p> <p><i>mirror cabinet, 3 mirror doors, 2 of them are arranged in a trapeze, 6 glass shelves, lateral and top LED lighting 20,8 W, 6000 Kelvin incl. switch/socket, EEC A-A++</i></p>	90	68,2	17,5	SDU9		2035
 <p>Spiegelpaneel, Sensorschalter, seitliche LED-Beleuchtung 2x 6,2 W 6000 Kelvin EEC A-A++</p> <p><i>mirror panel, sensor switch lateral LED-lighting 2x 6,2 W, 6000 Kelvin EEC A-A++</i></p>	90	68,2	2,8	SPBSA9	 	1074
 <p>LED-Aufbauleuchte für Spiegelpaneel mit LED-Mini-Stecker, 12,2 W, 6000 Kelvin, ohne Schalter, EEC A-A++</p> <p><i>LED-lighting for mirror panel with LED-mini-plug, 12,2 W, 6000 Kelvin, without switch, EEC A-A++</i></p>	90	2,4	10	AWP90		348



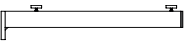







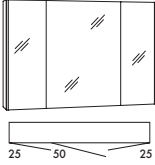

EEK/EEC=Energieeffizienzklasse/energy efficiency category

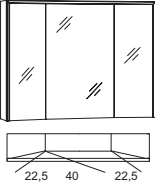
Beschreibung Description	Maße in cm Dimensions in cm			Artikel-Nr. Article no.	Türanschlag Door stop	Identnummer ID number
	B/W	H	T/D			
 <p>Aufsatz-Keramik-Washbecken inkl. Überlauf</p> <p><i>on-top ceramic washbasin incl. overflow</i></p>	56,0	15,0	38,0	KWPOC55		623
						
 <p>Waschtischkonsole Stahlrohr 4 x 4 cm, erforderlich</p> <p><i>washbasin mounting bracket steel 4 x 4 cm, required</i></p>	4,0	4,0	39,2	WK		134
						PG1 Dickkante/thick edge
 <p>Waschtischplatte ohne Ausfräsung</p> <p><i>Washbasin plate without notch</i></p>	80,0	4,0	48,5	WTP8		408
 <p>Waschtischplatte inkl. Ausfräsung mittig</p> <p><i>Washbasin plate with central notch</i></p>	80,0	4,0	48,5	WTPP8M		443
 <p>Waschtisch-Unterschrank 1 Schubkasten</p> <p><i>washbasin base cabinet 1 drawer</i></p>	77,0	23,8	47,8	GWPWS7		766
 <p>Waschtisch-Unterschrank 2 Schubkästen</p> <p><i>washbasin base cabinet 2 drawers</i></p>	77,0	36,6	47,8	GWPWS7		1053
 <p>Waschtisch-Unterschrank 1 Schubkasten, 1 Auszug</p> <p><i>washbasin base cabinet 1 drawer, 1 extension</i></p>	77,0	47,8	47,8	GWPWSA7		1197
 <p>Waschtisch-Unterschrank 2 Schubkästen, 1 Auszug</p> <p><i>washbasin base cabinet 2 drawers, 1 extension</i></p>	77,0	60,6	47,8	GWPWSA7		1437

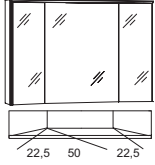

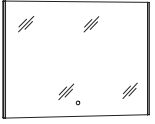





Beschreibung Description	Maße in cm Dimensions in cm			Artikel-Nr. Article no.	Türanschlag Door stop	Identnummer ID number
	B/W	H	T/D			
 <p>Spiegelschrank, 2 vollflächig verspiegelte Türen, 2 Glaseinlegeböden, seitliche LED-Beleuchtung 12,4 W, 6000 Kelvin inkl. Schalter/Steckdose, EEC A-A++</p> <p><i>mirror cabinet, 2 full mirrored doors 2 glass boards, lateral LED-lighting 12,4 W, 6000 Kelvin incl. switch/socket, EEC A-A++</i></p>	80,0	68,2	17,6	SADA8L		1552
 <p>Spiegelschrank, 2 vollflächig verspiegelte Türen, 2 Glaseinlegeböden, seitliche LED-Beleuchtung 12,4 W, 6000 Kelvin inkl. Schalter/Steckdose, EEC A-A++</p> <p><i>mirror cabinet, 2 full mirrored doors 2 glass boards, lateral LED-lighting 12,4 W, 6000 Kelvin incl. switch/socket, EEC A-A++</i></p>	80,0	68,2	17,6	SADA8R		1552
 <p>LED-Aufbauleuchte für Spiegelschrank mit LED-Mini-Stecker, 10,8 W, 6000 Kelvin, ohne Schalter, EEC A-A++</p> <p><i>LED lighting for mirror cabinet with LED-mini-plug, 10,8 W, 6000 Kelvin, without switch, EEC A-A++</i></p>	80	2,4	20	AW80		423
 <p>Spiegelschrank, 3 Spiegeltüren davon 2 trapezförmig angeordnet, 6 Glaseinlegeböden, seitlich und oben LED-Beleuchtung, 19,8 W, 6000 Kelvin, inkl. Schalter/Steckdose, EEC A-A++</p> <p><i>mirror cabinet, 3 mirror doors, 2 of them are arranged in a trapeze, 6 glass shelves, lateral and top LED lighting 19,8 W, 6000 Kelvin incl. switch/socket, EEC A-A++</i></p>	80	68,2	17,5	SDU8		1963
 <p>Spiegelschrank, 3 Spiegeltüren davon 2 trapezförmig angeordnet, 6 Glaseinlegeböden, seitlich und oben LED-Beleuchtung, 20,8 W, 6000 Kelvin, inkl. Schalter/Steckdose, EEC A-A++</p> <p><i>mirror cabinet, 3 mirror doors, 2 of them are arranged in a trapeze, 6 glass shelves, lateral and top LED lighting 20,8 W, 6000 Kelvin incl. switch/socket, EEC A-A++</i></p>	90	68,2	17,5	SDU9		2035
 <p>Spiegelpaneel, Sensorschalter, seitliche LED-Beleuchtung 2x 6,2 W 6000 Kelvin EEC A-A++</p> <p><i>mirror panel, sensor switch lateral LED-lighting 2x 6,2 W, 6000 Kelvin EEC A-A++</i></p>	90	68,2	2,8	SPBSA9	 	1074
 <p>LED-Aufbauleuchte für Spiegelpaneel mit LED-Mini-Stecker, 12,2 W, 6000 Kelvin, ohne Schalter, EEC A-A++</p> <p><i>LED-lighting for mirror panel with LED-mini-plug, 12,2 W, 6000 Kelvin, without switch, EEC A-A++</i></p>	90	2,4	10	AWP90		348

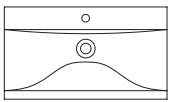

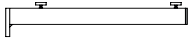







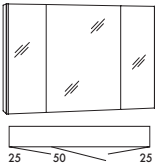

EEK/EEC=Energieeffizienzklasse/energy efficiency category

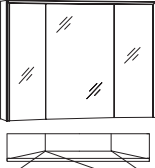
Beschreibung Description	Maße in cm Dimensions in cm			Artikel-Nr. Article no.	Türanschlag Door stop	Identnummer ID number
	B/W	H	T/D			
 <p>Aufsatz-Mineralmarmor-Washbecken inkl. Überlaufgarnitur und Montageset MONK-4</p> <p><i>on-top marble minerals washbasin incl. overflow and mounting-set MONK-4</i></p>	60,0	12,0	45,0	MWING6		946
						
 <p>Waschtischkonsole Stahlrohr 4 x 4 cm, erforderlich</p> <p><i>washbasin mounting bracket steel 4 x 4 cm, required</i></p>	4,0	4,0	39,2	WK		134
						PG1 Dickkante/thick edge
 <p>Waschtischplatte ohne Ausfräsung</p> <p><i>Washbasin plate without notch</i></p>	100,0	4,0	48,5	WTP10		503
 <p>Waschtischplatte inkl. Ausfräsung mittig</p> <p><i>Washbasin plate with central notch</i></p>	100,0	4,0	48,5	WTP10M		527
 <p>Waschtisch-Unterschrank 1 Schubkasten</p> <p><i>washbasin base cabinet 1 drawer</i></p>	97,0	23,8	47,8	GWPWS9		814
 <p>Waschtisch-Unterschrank 2 Schubkästen</p> <p><i>washbasin base cabinet 2 drawers</i></p>	97,0	36,6	47,8	GWPWSS9		1126
 <p>Waschtisch-Unterschrank 1 Schubkasten, 1 Auszug</p> <p><i>washbasin base cabinet 1 drawer, 1 extension</i></p>	97,0	47,8	47,8	GWPWSA9		1317
 <p>Waschtisch-Unterschrank 2 Schubkästen, 1 Auszug</p> <p><i>washbasin base cabinet 2 drawers, 1 extension</i></p>	97,0	60,6	47,8	GWPWSSA9		1580

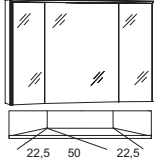

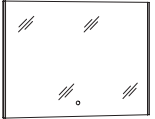





Beschreibung Description	Maße in cm Dimensions in cm			Artikel-Nr. Article no.	Türanschlag Door stop	Identnummer ID number
	B/W	H	T/D			
 <p>Spiegelschrank, 3 vollflächig verspiegelte Türen, 4 Glaseinlegeböden, seitliche LED-Beleuchtung 12,4 W, 6000 Kelvin inkl. Schalter/Steckdose EEK A–A++</p> <p><i>mirror cabinet, 3 full mirrored doors 4 glass boards, lateral LED-lighting 12,4 W, 6000 Kelvin incl. switch/socket EEC A–A++</i></p>	100	68,2	17,6	SADA10		1735
 <p>LED-Aufbauleuchte für Spiegelschrank mit LED-Mini-Stecker, 13,7 W, 6000 Kelvin, ohne Schalter, EEK A–A++</p> <p><i>LED-lighting for mirror cabinet with LED-mini-plug, 13,7 W, 6000 Kelvin, without switch, EEC A–A++</i></p>	100	2,4	20	AW100		473
 <p>Spiegelschrank, 3 Spiegeltüren davon 2 trapezförmig angeordnet, 6 Glaseinlegeböden, seitlich und oben LED-Beleuchtung, 20,8 W, 6000 Kelvin, inkl. Schalter/Steckdose, EEK A–A++</p> <p><i>mirror cabinet, 3 mirror doors, 2 of them are arranged in a trapeze, 6 glass shelves, lateral and top LED lighting 20,8 W, 6000 Kelvin incl. switch/socket, EEC A–A++</i></p>	90	68,2	17,5	SDU9		2035
 <p>Spiegelschrank, 3 Spiegeltüren davon 2 trapezförmig angeordnet, 6 Glaseinlegeböden, seitlich und oben LED-Beleuchtung, 21,9 W, 6000 Kelvin, inkl. Schalter/Steckdose, EEK A–A++</p> <p><i>mirror cabinet, 3 mirror doors, 2 of them are arranged in a trapeze, 6 glass shelves, lateral and top LED lighting 21,9 W, 6000 Kelvin incl. switch/socket, EEC A–A++</i></p>	100	68,2	17,5	SDU10		2107
 <p>Spiegelpaneel, Sensorschalter, seitliche LED-Beleuchtung 2x 6,2 W 6000 Kelvin EEK A–A++</p> <p><i>mirror panel, sensor switch lateral LED-lighting 2x 6,2 W, 6000 Kelvin EEC A–A++</i></p>	90	68,2	2,8	SPBSA9	 	1074
 <p>LED-Aufbauleuchte für Spiegelpaneel mit LED-Mini-Stecker, 12,2 W, 6000 Kelvin, ohne Schalter, EEK A–A++</p> <p><i>LED-lighting for mirror panel with LED-mini-plug, 12,2 W, 6000 Kelvin, without switch, EEC A–A++</i></p>	90	2,4	10	AWP90		348

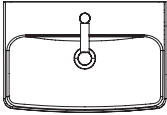

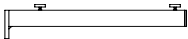







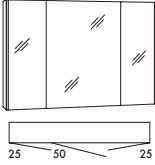

EEK/EEC=Energieeffizienzklasse/energy efficiency category

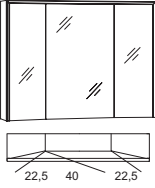
Beschreibung Description	Maße in cm Dimensions in cm			Artikel-Nr. Article no.	Türanschlag Door stop	Identnummer ID number
	B/W	H	T/D			
 <p>Aufsatz-Keramik-Washbecken inkl. Überlauf</p> <p><i>on-top ceramic washbasin incl. overflow</i></p>	71,0	16,0	44,5	KWBEL7		801
						
 <p>Waschtischkonsole Stahlrohr 4 x 4 cm, erforderlich</p> <p><i>washbasin mounting bracket steel 4 x 4 cm, required</i></p>	4,0	4,0	39,2	WK		134
						PG1 Dickkante/thick edge
 <p>Waschtischplatte ohne Ausfräsung</p> <p><i>Washbasin plate without notch</i></p>	100,0	4,0	48,5	WTP10		503
 <p>Waschtischplatte inkl. Ausfräsung mittig</p> <p><i>Washbasin plate with central notch</i></p>	100,0	4,0	48,5	WTPB10M		527
 <p>Waschtisch-Unterschrank 1 Schubkasten</p> <p><i>washbasin base cabinet 1 drawer</i></p>	97,0	23,8	47,8	GWPWS9		814
 <p>Waschtisch-Unterschrank 2 Schubkästen</p> <p><i>washbasin base cabinet 2 drawers</i></p>	97,0	36,6	47,8	GWPWS9		1126
 <p>Waschtisch-Unterschrank 1 Schubkasten, 1 Auszug</p> <p><i>washbasin base cabinet 1 drawer, 1 extension</i></p>	97,0	47,8	47,8	GWPWSA9		1317
 <p>Waschtisch-Unterschrank 2 Schubkästen, 1 Auszug</p> <p><i>washbasin base cabinet 2 drawers, 1 extension</i></p>	97,0	60,6	47,8	GWPWSSA9		1580

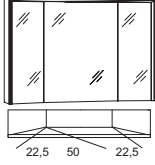
Beschreibung Description	Maße in cm Dimensions in cm			Artikel-Nr. Article no.	Türanschlag Door stop	Identnummer ID number
	B/W	H	T/D			
 <p>Spiegelschrank, 3 vollflächig verspiegelte Türen, 4 Glaseinlegeböden, seitliche LED-Beleuchtung 12,4 W, 6000 Kelvin inkl. Schalter/Steckdose EEK A–A++</p> <p><i>mirror cabinet, 3 full mirrored doors 4 glass boards, lateral LED-lighting 12,4 W, 6000 Kelvin incl. switch/socket EEC A–A++</i></p>	100	68,2	17,6	SADA10		1735
 <p>LED-Aufbauleuchte für Spiegelschrank mit LED-Mini-Stecker, 13,7 W, 6000 Kelvin, ohne Schalter, EEK A–A++</p> <p><i>LED-lighting for mirror cabinet with LED-mini-plug, 13,7 W, 6000 Kelvin, without switch, EEC A–A++</i></p>	100	2,4	20	AW100		473
 <p>Spiegelschrank, 3 Spiegeltüren davon 2 trapezförmig angeordnet, 6 Glaseinlegeböden, seitlich und oben LED-Beleuchtung, 20,8 W, 6000 Kelvin, inkl. Schalter/Steckdose, EEK A–A++</p> <p><i>mirror cabinet, 3 mirror doors, 2 of them are arranged in a trapeze, 6 glass shelves, lateral and top LED lighting 20,8 W, 6000 Kelvin incl. switch/socket, EEC A–A++</i></p>	90	68,2	17,5	SDU9		2035
 <p>Spiegelschrank, 3 Spiegeltüren davon 2 trapezförmig angeordnet, 6 Glaseinlegeböden, seitlich und oben LED-Beleuchtung, 21,9 W, 6000 Kelvin, inkl. Schalter/Steckdose, EEK A–A++</p> <p><i>mirror cabinet, 3 mirror doors, 2 of them are arranged in a trapeze, 6 glass shelves, lateral and top LED lighting 21,9 W, 6000 Kelvin incl. switch/socket, EEC A–A++</i></p>	100	68,2	17,5	SDU10		2107
 <p>Spiegelpaneel, Sensorschalter, seitliche LED-Beleuchtung 2x 6,2 W 6000 Kelvin EEK A–A++</p> <p><i>mirror panel, sensor switch lateral LED-lighting 2x 6,2 W, 6000 Kelvin EEC A–A++</i></p>	90	68,2	2,8	SPBSA9	 	1074
 <p>LED-Aufbauleuchte für Spiegelpaneel mit LED-Mini-Stecker, 12,2 W, 6000 Kelvin, ohne Schalter, EEK A–A++</p> <p><i>LED-lighting for mirror panel with LED-mini-plug, 12,2 W, 6000 Kelvin, without switch, EEC A–A++</i></p>	90	2,4	10	AWP90		348

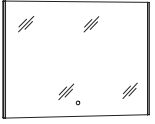







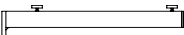

EEK/EEC=Energieeffizienzklasse/energy efficiency category

Beschreibung Description	Maße in cm Dimensions in cm			Artikel-Nr. Article no.	Türanschlag Door stop	Identnummer ID number
	B/W	H	T/D			
 <p>Aufsatz-Keramik-Washbecken inkl. Überlauf</p> <p><i>on-top ceramic washbasin incl. overflow</i></p>	56,0	15,0	38,0	KWPOC55		623
						
 <p>Waschtischkonsole Stahlrohr 4 x 4 cm, erforderlich</p> <p><i>washbasin mounting bracket steel 4 x 4 cm, required</i></p>	4,0	4,0	39,2	WK		134
						PG1 Dickkante/ <i>thick edge</i>
 <p>Waschtischplatte ohne Ausfräsung</p> <p><i>Washbasin plate without notch</i></p>	100,0	4,0	48,5	WTP10		503
 <p>Waschtischplatte inkl. Ausfräsung mittig</p> <p><i>Washbasin plate with central notch</i></p>	100,0	4,0	48,5	WTPP10M		527
 <p>Waschtisch-Unterschrank 1 Schubkasten</p> <p><i>washbasin base cabinet 1 drawer</i></p>	97,0	23,8	47,8	GWPWS9		814
 <p>Waschtisch-Unterschrank 2 Schubkästen</p> <p><i>washbasin base cabinet 2 drawers</i></p>	97,0	36,6	47,8	GWPWS9		1126
 <p>Waschtisch-Unterschrank 1 Schubkasten, 1 Auszug</p> <p><i>washbasin base cabinet 1 drawer, 1 extension</i></p>	97,0	47,8	47,8	GWPWSA9		1317
 <p>Waschtisch-Unterschrank 2 Schubkästen, 1 Auszug</p> <p><i>washbasin base cabinet 2 drawers, 1 extension</i></p>	97,0	60,6	47,8	GWPWSSA9		1580

Beschreibung Description	Maße in cm Dimensions in cm			Artikel-Nr. Article no.	Türanschlag Door stop	Identnummer ID number
	B/W	H	T/D			
 <p>Spiegelschrank, 3 vollflächig verspiegelte Türen, 4 Glaseinlegeböden, seitliche LED-Beleuchtung 12,4 W, 6000 Kelvin inkl. Schalter/Steckdose EEK A–A++</p> <p><i>mirror cabinet, 3 full mirrored doors 4 glass boards, lateral LED-lighting 12,4 W, 6000 Kelvin incl. switch/socket EEC A–A++</i></p>	100	68,2	17,6	SADA10		1735
 <p>LED-Aufbauleuchte für Spiegelschrank mit LED-Mini-Stecker, 13,7 W, 6000 Kelvin, ohne Schalter, EEK A–A++</p> <p><i>LED-lighting for mirror cabinet with LED-mini-plug, 13,7 W, 6000 Kelvin, without switch, EEC A–A++</i></p>	100	2,4	20	AW100		473
 <p>Spiegelschrank, 3 Spiegeltüren davon 2 trapezförmig angeordnet, 6 Glaseinlegeböden, seitlich und oben LED-Beleuchtung, 20,8 W, 6000 Kelvin, inkl. Schalter/Steckdose, EEK A–A++</p> <p><i>mirror cabinet, 3 mirror doors, 2 of them are arranged in a trapeze, 6 glass shelves, lateral and top LED lighting 20,8 W, 6000 Kelvin incl. switch/socket, EEC A–A++</i></p>	90	68,2	17,5	SDU9		2035
 <p>Spiegelschrank, 3 Spiegeltüren davon 2 trapezförmig angeordnet, 6 Glaseinlegeböden, seitlich und oben LED-Beleuchtung, 21,9 W, 6000 Kelvin, inkl. Schalter/Steckdose, EEK A–A++</p> <p><i>mirror cabinet, 3 mirror doors, 2 of them are arranged in a trapeze, 6 glass shelves, lateral and top LED lighting 21,9 W, 6000 Kelvin incl. switch/socket, EEC A–A++</i></p>	100	68,2	17,5	SDU10		2107
 <p>Spiegelpaneel, Sensorschalter, seitliche LED-Beleuchtung 2x 6,2 W 6000 Kelvin EEK A–A++</p> <p><i>mirror panel, sensor switch lateral LED-lighting 2x 6,2 W, 6000 Kelvin EEC A–A++</i></p>	90	68,2	2,8	SPBSA9	 	1074
 <p>LED-Aufbauleuchte für Spiegelpaneel mit LED-Mini-Stecker, 12,2 W, 6000 Kelvin, ohne Schalter, EEK A–A++</p> <p><i>LED-lighting for mirror panel with LED-mini-plug, 12,2 W, 6000 Kelvin, without switch, EEC A–A++</i></p>	90	2,4	10	AWP90		348





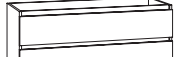





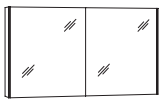

EEK/EEC=Energieeffizienzklasse/energy efficiency category

3390 »120 cm INGA L und R/ 120 cm INGA L and R«

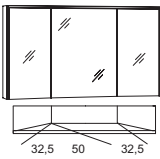
Beschreibung Description	Maße in cm Dimensions in cm			Artikel-Nr. Article no.	Türanschlag Door stop	Identnummer ID number
	B/W	H	T/D			
 <p>Aufsatz-Mineralmarmor-Waschbecken inkl. Überlaufgarnitur und Montageset MONK-4</p> <p><i>on-top marble minerals washbasin incl. overflow and mounting-set MONK-4</i></p>	60,0	12,0	45,0	MWING6		946
						
 <p>Waschtischkonsole Stahlrohr 4 x 4 cm, erforderlich</p> <p><i>washbasin mounting bracket steel 4 x 4 cm, required</i></p>	4,0	4,0	39,2	WK		134
						PG1 Dickkante/ <i>thick edge</i>
 <p>Waschtischplatte ohne Ausfräsung</p> <p><i>Washbasin plate without notch</i></p>	120,0	4,0	48,5	WTP12		572
 <p>Waschtischplatte inkl. Ausfräsung links</p> <p><i>Washbasin plate with notch left</i></p>	120,0	4,0	48,5	WTP12L		607
 <p>Waschtischplatte inkl. Ausfräsung rechts</p> <p><i>Washbasin plate with notch right</i></p>	120,0	4,0	48,5	WTP12R		607
 <p>Waschtisch-Unterschrank, Waschtisch links 1 Schubkasten</p> <p><i>washbasin base cabinet, washbasin left 1 drawer</i></p>	117,0	23,8	47,8	GWPWS11L		862
 <p>Waschtisch-Unterschrank, Waschtisch rechts 1 Schubkasten</p> <p><i>washbasin base cabinet, washbasin right 1 drawer</i></p>	117,0	23,8	47,8	GWPWS11R		862
 <p>Waschtisch-Unterschrank, Waschtisch links 2 Schubkästen</p> <p><i>washbasin base cabinet, washbasin left 2 drawers</i></p>	117,0	36,6	47,8	GWPWS11L		1197
 <p>Waschtisch-Unterschrank, Waschtisch rechts 2 Schubkästen</p> <p><i>washbasin base cabinet, washbasin right 2 drawers</i></p>	117,0	36,6	47,8	GWPWS11R		1197
 <p>Waschtisch-Unterschrank, Waschtisch links 1 Schubkasten, 1 Auszug</p> <p><i>washbasin base cabinet, washbasin left 1 drawer, 1 extension</i></p>	117,0	47,8	47,8	GWPWSA11L		1437
 <p>Waschtisch-Unterschrank, Waschtisch rechts 1 Schubkasten, 1 Auszug</p> <p><i>washbasin base cabinet, washbasin right 1 drawer, 1 extension</i></p>	117,0	47,8	47,8	GWPWSA11R		1437

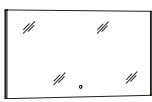

EEK/EEC=Energieeffizienzklasse/energy efficiency category



3390 »120 cm INGA L und R/ 120 cm INGA L and R«



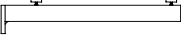

Beschreibung Description	Maße in cm Dimensions in cm			Artikel-Nr. Article no.	Türanschlag Door stop	Identnummer ID number
	B/W	H	T/D			
 <p>Waschtisch-Unterschrank, Waschtisch links 2 Schubkästen, 1 Auszug</p> <p><i>washbasin base cabinet, washbasin left 2 drawers, 1 extension</i></p>	117,0	60,6	47,8	GWPWSSA11L		PG1 Dickkante/ <i>thick edge</i> 1724
 <p>Waschtisch-Unterschrank, Waschtisch rechts 2 Schubkästen, 1 Auszug</p> <p><i>washbasin base cabinet, washbasin right 2 drawers, 1 extension</i></p>	117,0	60,6	47,8	GWPWSSA11R		1724
 <p>Spiegelschrank, 2 vollflächig verspiegelte Türen, 4 Glaseinlegeböden, seitliche LED-Beleuchtung 12,4 W, 6000 Kelvin inkl. Schalter/Steckdose EEK A-A++</p> <p><i>mirror cabinet, 2 full mirrored doors 4 glass boards, lateral LED-lighting 12,4 W, 6000 Kelvin incl. switch/socket EEC A-A++</i></p>	120	68,2	17,6	SADA12D		1687
 <p>LED-Aufbauleuchte für Spiegelschrank mit LED-Mini-Stecker, 16,6 W, 6000 Kelvin, ohne Schalter, EEK A-A++</p> <p><i>LED-lighting for mirror cabinet with LED-mini-plug, 16,6 W, 6000 Kelvin, without switch, EEC A-A++</i></p>	120	2,4	20	AW120		522
 <p>Spiegelschrank, 3 Spiegeltüren davon 2 trapezförmig angeordnet, 6 Glasein- legeböden, seitlich und oben LED- Beleuchtung, 23,6 W, 6000 Kelvin, inkl. Schalter/Steckdose, EEK A-A++</p> <p><i>mirror cabinet, 3 mirror doors, 2 of them are arranged in a trapeze, 6 glass shelves, lateral and top LED lighting 23,6 W, 6000 Kelvin incl. switch/socket, EEC A-A++</i></p>	120	68,2	17,5	SDU12		2251
 <p>Spiegelpanel, Sensorschalter seitliche LED-Beleuchtung 2x 6,2 W 6000 Kelvin, EEK A-A++</p> <p><i>mirror panel, sensor switch lateral LED-lighting 2x 6,2 W 6000 Kelvin, EEC A-A++</i></p>	120	68,2	2,8	SPBSA12	 	1144
 <p>LED-Aufbauleuchte für Spiegelpanel mit LED-Mini-Stecker, 16,9 W, 6000 Kelvin, ohne Schalter, EEK A-A++</p> <p><i>LED-lighting for mirror panel with LED-mini-plug, 16,9 W, 6000 Kelvin, without switch, EEC A-A++</i></p>	120	2,4	10	AWP120		398









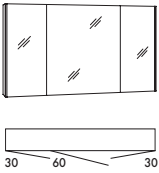

EEK/EEC=Energieeffizienzklasse/energy efficiency category

Beschreibung Description	Maße in cm Dimensions in cm			Artikel-Nr. Article no.	Türanschlag Door stop	Identnummer ID number
	B/W	H	T/D			

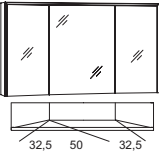
	Aufsatz-Mineralmarmor-Waschbecken inkl. Überlaufgarnitur und Montageset MONK-4 <i>on-top marble minerals washbasin incl. overflow and mounting-set MONK-4</i>	60,0	12,0	45,0	MWING6 		946
	Waschtischkonsole Stahlrohr 4 x 4 cm, erforderlich <i>washbasin mounting bracket steel 4 x 4 cm, required</i>	4,0	4,0	39,2	WK		134

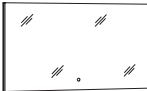







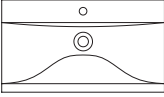
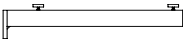

							PG1 Dickkante/thick edge
	Waschtischplatte ohne Ausfräsung <i>Washbasin plate without notch</i>	120,0	4,0	48,5	WTP12		572
	Waschtischplatte inkl. Ausfräsung mittig <i>Washbasin plate with central notch</i>	120,0	4,0	48,5	WTPI12M		607

	Waschtisch-Unterschrank, Waschtisch mittig 1 Schubkasten <i>washbasin base cabinet, washbasin center 1 drawer</i>	117,0	23,8	47,8	GWPWS11M		862
	Waschtisch-Unterschrank, Waschtisch mittig 2 Schubkästen <i>washbasin base cabinet, washbasin center 2 drawers</i>	117,0	36,6	47,8	GWPWSS11M		1197
	Waschtisch-Unterschrank, Waschtisch mittig 1 Schubkasten, 1 Auszug <i>washbasin base cabinet, washbasin center 1 drawer, 1 extension</i>	117,0	47,8	47,8	GWPWSA11M		1437
	Waschtisch-Unterschrank, Waschtisch mittig 2 Schubkästen, 1 Auszug <i>washbasin base cabinet, washbasin center 2 drawers, 1 extension</i>	117,0	60,6	47,8	GWPWSSA11M		1724











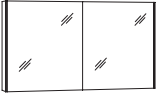

Beschreibung Description	Maße in cm Dimensions in cm			Artikel-Nr. Article no.	Türanschlag Door stop	Identnummer ID number
	B/W	H	T/D			
 <p>Spiegelschrank, 3 vollflächig verspiegelte Türen, 6 Glaseinlegeböden, seitliche LED-Beleuchtung 12,4 W, 6000 Kelvin inkl. Schalter/Steckdose EEK A–A++</p> <p><i>mirror cabinet, 3 full mirrored doors, 6 glass boards, lateral LED-lighting 12,4 W, 6000 Kelvin incl. switch/socket EEC A–A++</i></p>	120	68,2	17,6	SADA12		1934
 <p>LED-Aufbauleuchte für Spiegelschrank mit LED-Mini-Stecker, 16,6 W, 6000 Kelvin, ohne Schalter, EEK A–A++</p> <p><i>LED-lighting for mirror cabinet with LED-mini-plug, 16,6 W, 6000 Kelvin, without switch, EEC A–A++</i></p>	120	2,4	20	AW120		522
 <p>Spiegelschrank, 3 Spiegeltüren davon 2 trapezförmig angeordnet, 6 Glaseinlegeböden, seitlich und oben LED-Beleuchtung, 23,6 W, 6000 Kelvin, inkl. Schalter/Steckdose, EEK A–A++</p> <p><i>mirror cabinet, 3 mirror doors, 2 of them are arranged in a trapeze, 6 glass shelves, lateral and top LED lighting 23,6 W, 6000 Kelvin incl. switch/socket, EEC A–A++</i></p>	120	68,2	17,5	SDU12		2251
 <p>Spiegelpaneel, Sensorschalter seitliche LED-Beleuchtung 2x 6,2 W 6000 Kelvin, EEK A–A++</p> <p><i>mirror panel, sensor switch lateral LED-lighting 2x 6,2 W 6000 Kelvin, EEC A–A++</i></p>	120	68,2	2,8	SPBSA12	 	1144
 <p>LED-Aufbauleuchte für Spiegelpaneel mit LED-Mini-Stecker, 16,9 W, 6000 Kelvin, ohne Schalter, EEK A–A++</p> <p><i>LED-lighting for mirror panel with LED-mini-plug, 16,9 W, 6000 Kelvin, without switch, EEC A–A++</i></p>	120	2,4	10	AWP120		398

EEK/EEC=Energieeffizienzklasse/energy efficiency category

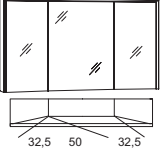







3390 »120 cm BELLA L und R/ 120 cm BELLA L and R«

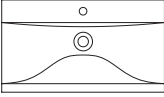

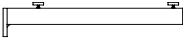





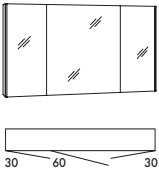

Beschreibung Description	Maße in cm Dimensions in cm			Artikel-Nr. Article no.	Türanschlag Door stop	Identnummer ID number
	B/W	H	T/D			
 <p>Aufsatz-Keramik-Waschbecken inkl. Überlauf</p> <p><i>on-top ceramic washbasin incl. overflow</i></p>	71,0	16,0	44,5	KWBEL7		801
 <p>Waschtischkonsole Stahlrohr 4 x 4 cm, erforderlich</p> <p><i>washbasin mounting bracket steel 4 x 4 cm, required</i></p>	4,0	4,0	39,2	WK		134
						PG1 Dickkante/thick edge
 <p>Waschtischplatte ohne Ausfräsung</p> <p><i>Washbasin plate without notch</i></p>	120,0	4,0	48,5	WTP12		572
 <p>Waschtischplatte inkl. Ausfräsung links</p> <p><i>Washbasin plate with notch left</i></p>	120,0	4,0	48,5	WTPB12L		607
 <p>Waschtischplatte inkl. Ausfräsung rechts</p> <p><i>Washbasin plate with notch right</i></p>	120,0	4,0	48,5	WTPB12R		607
 <p>Waschtisch-Unterschrank, Waschtisch links 1 Schubkasten</p> <p><i>washbasin base cabinet, washbasin left 1 drawer</i></p>	117,0	23,8	47,8	GWPWS11L		862
 <p>Waschtisch-Unterschrank, Waschtisch rechts 1 Schubkasten</p> <p><i>washbasin base cabinet, washbasin right 1 drawer</i></p>	117,0	23,8	47,8	GWPWS11R		862
 <p>Waschtisch-Unterschrank, Waschtisch links 2 Schubkästen</p> <p><i>washbasin base cabinet, washbasin left 2 drawers</i></p>	117,0	36,6	47,8	GWPWSS11L		1197
 <p>Waschtisch-Unterschrank, Waschtisch rechts 2 Schubkästen</p> <p><i>washbasin base cabinet, washbasin right 2 drawers</i></p>	117,0	36,6	47,8	GWPWSS11R		1197
 <p>Waschtisch-Unterschrank, Waschtisch links 1 Schubkasten, 1 Auszug</p> <p><i>washbasin base cabinet, washbasin left 1 drawer, 1 extension</i></p>	117,0	47,8	47,8	GWPWSA11L		1437
 <p>Waschtisch-Unterschrank, Waschtisch rechts 1 Schubkasten, 1 Auszug</p> <p><i>washbasin base cabinet, washbasin right 1 drawer, 1 extension</i></p>	117,0	47,8	47,8	GWPWSA11R		1437

3390 »120 cm BELLA L und R/ 120 cm BELLA L and R«

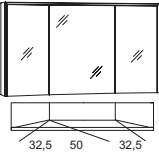
Beschreibung Description	Maße in cm Dimensions in cm			Artikel-Nr. Article no.	Türanschlag Door stop	Identnummer ID number
	B/W	H	T/D			
 <p>Waschtisch-Unterschrank Waschtisch links 2 Schubkästen, 1 Auszug</p> <p><i>washbasin base cabinet washbasin left 2 drawers, 1 extension</i></p>	117,0	60,6	47,8	GWPWSSA11L		PG1 Dickkante/ <i>thick edge</i> 1724
 <p>Waschtisch-Unterschrank Waschtisch rechts 2 Schubkästen, 1 Auszug</p> <p><i>washbasin base cabinet washbasin right 2 drawers, 1 extension</i></p>	117,0	60,6	47,8	GWPWSSA11R		1724
 <p>Spiegelschrank, 2 vollflächig verspiegelte Türen, 4 Glaseinlegeböden, seitliche LED-Beleuchtung 12,4 W, 6000 Kelvin inkl. Schalter/Steckdose EEK A-A++</p> <p><i>mirror cabinet, 2 full mirrored doors 4 glass boards, lateral LED-lighting 12,4 W, 6000 Kelvin incl. switch/socket EEC A-A++</i></p>	120	68,2	17,6	SADA12D		1687
 <p>LED-Aufbauleuchte für Spiegelschrank mit LED-Mini-Stecker, 16,6 W, 6000 Kelvin, ohne Schalter, EEK A-A++</p> <p><i>LED-lighting for mirror cabinet with LED-mini-plug, 16,6 W, 6000 Kelvin, without switch, EEC A-A++</i></p>	120	2,4	20	AW120		522
 <p>Spiegelschrank, 3 Spiegeltüren davon 2 trapezförmig angeordnet, 6 Glasein- legeböden, seitlich und oben LED- Beleuchtung, 23,6 W, 6000 Kelvin, inkl. Schalter/Steckdose, EEK A-A++</p> <p><i>mirror cabinet, 3 mirror doors, 2 of them are arranged in a trapeze, 6 glass shelves, lateral and top LED lighting 23,6 W, 6000 Kelvin incl. switch/socket, EEC A-A++</i></p>	120	68,2	17,5	SDU12		2251
 <p>Spiegelpaneel, Sensorschalter seitliche LED-Beleuchtung 2x 6,2 W 6000 Kelvin, EEK A-A++</p> <p><i>mirror panel, sensor switch lateral LED-lighting 2x 6,2 W 6000 Kelvin, EEC A-A++</i></p>	120	68,2	2,8	SPBSA12	 	1144
 <p>LED-Aufbauleuchte für Spiegelpaneel mit LED-Mini-Stecker, 16,9 W, 6000 Kelvin, ohne Schalter, EEK A-A++</p> <p><i>LED-lighting for mirror panel with LED-mini-plug, 16,9 W, 6000 Kelvin, without switch, EEC A-A++</i></p>	120	2,4	10	AWP120		398

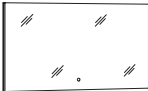









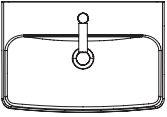

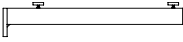
EEK/EEC=Energieeffizienzklasse/energy efficiency category

Beschreibung Description	Maße in cm Dimensions in cm			Artikel-Nr. Article no.	Türanschlag Door stop	Identnummer ID number
	B/W	H	T/D			
 <p>Aufsatz-Keramik-Waschbecken inkl. Überlauf</p> <p><i>on-top ceramic washbasin incl. overflow</i></p>	71,0	16,0	44,5	KWBEL7		801
						
 <p>Waschtischkonsole Stahlrohr 4 x 4 cm, erforderlich</p> <p><i>washbasin mounting bracket steel 4 x 4 cm, required</i></p>	4,0	4,0	39,2	WK		134
						PG1 Dickkante/ <i>thick edge</i>
 <p>Waschtischplatte ohne Ausfräsung</p> <p><i>Washbasin plate without notch</i></p>	120,0	4,0	48,5	WTP12		572
 <p>Waschtischplatte inkl. Ausfräsung mittig</p> <p><i>Washbasin plate with central notch</i></p>	120,0	4,0	48,5	WTPB12M		607
 <p>Waschtisch-Unterschrank 1 Schubkasten</p> <p><i>washbasin base cabinet 1 drawer</i></p>	117,0	23,8	47,8	GWPWS11M		862
 <p>Waschtisch-Unterschrank 2 Schubkästen</p> <p><i>washbasin base cabinet 2 drawers</i></p>	117,0	36,6	47,8	GWPWS11M		1197
 <p>Waschtisch-Unterschrank 1 Schubkasten, 1 Auszug</p> <p><i>washbasin base cabinet 1 drawer, 1 extension</i></p>	117,0	47,8	47,8	GWPWSA11M		1437
 <p>Waschtisch-Unterschrank 2 Schubkästen, 1 Auszug</p> <p><i>washbasin base cabinet 2 drawers, 1 extension</i></p>	117,0	60,6	47,8	GWPWSSA11M		1724











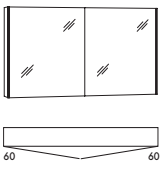

Beschreibung Description	Maße in cm Dimensions in cm			Artikel-Nr. Article no.	Türanschlag Door stop	Identnummer ID number
	B/W	H	T/D			
 <p>Spiegelschrank, 3 vollflächig verspiegelte Türen, 6 Glaseinlegeböden, seitliche LED-Beleuchtung 12,4 W, 6000 Kelvin inkl. Schalter/Steckdose EEK A–A++</p> <p><i>mirror cabinet, 3 full mirrored doors, 6 glass boards, lateral LED-lighting 12,4 W, 6000 Kelvin incl. switch/socket EEC A–A++</i></p>	120	68,2	17,6	SADA12		1934
 <p>LED-Aufbauleuchte für Spiegelschrank mit LED-Mini-Stecker, 16,6 W, 6000 Kelvin, ohne Schalter, EEK A–A++</p> <p><i>LED-lighting for mirror cabinet with LED-mini-plug, 16,6 W, 6000 Kelvin, without switch, EEC A–A++</i></p>	120	2,4	20	AW120		522
 <p>Spiegelschrank, 3 Spiegeltüren davon 2 trapezförmig angeordnet, 6 Glaseinlegeböden, seitlich und oben LED-Beleuchtung, 23,6 W, 6000 Kelvin, inkl. Schalter/Steckdose, EEK A–A++</p> <p><i>mirror cabinet, 3 mirror doors, 2 of them are arranged in a trapeze, 6 glass shelves, lateral and top LED lighting 23,6 W, 6000 Kelvin incl. switch/socket, EEC A–A++</i></p>	120	68,2	17,5	SDU12		2251
 <p>Spiegelpaneel, Sensorschalter seitliche LED-Beleuchtung 2x 6,2 W 6000 Kelvin, EEK A–A++</p> <p><i>mirror panel, sensor switch lateral LED-lighting 2x 6,2 W 6000 Kelvin, EEC A–A++</i></p>	120	68,2	2,8	SPBSA12	 	1144
 <p>LED-Aufbauleuchte für Spiegelpaneel mit LED-Mini-Stecker, 16,9 W, 6000 Kelvin, ohne Schalter, EEK A–A++</p> <p><i>LED-lighting for mirror panel with LED-mini-plug, 16,9 W, 6000 Kelvin, without switch, EEC A–A++</i></p>	120	2,4	10	AWP120		398

EEK/EEC=Energieeffizienzklasse/energy efficiency category

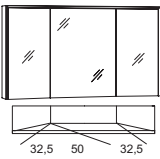







3390 »120 cm POCO L und R/ 120 cm POCO L and R«

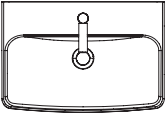

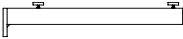

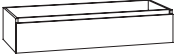



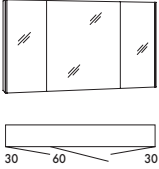

Beschreibung Description	Maße in cm Dimensions in cm			Artikel-Nr. Article no.	Türanschlag Door stop	Identnummer ID number
	B/W	H	T/D			
 <p>Aufsatz-Keramik-Waschbecken inkl. Überlauf</p> <p><i>on-top ceramic washbasin incl. overflow</i></p>	56,0	15,0	38,0	KWPOC55		623
						
 <p>Waschtischkonsole Stahlrohr 4 x 4 cm, erforderlich</p> <p><i>washbasin mounting bracket steel 4 x 4 cm, required</i></p>	4,0	4,0	39,2	WK		134
						PG1 Dickkante/thick edge
 <p>Waschtischplatte ohne Ausfräsung</p> <p><i>Washbasin plate without notch</i></p>	120,0	4,0	48,5	WTP12		572
 <p>Waschtischplatte inkl. Ausfräsung links</p> <p><i>Washbasin plate with notch left</i></p>	120,0	4,0	48,5	WTPP12L		607
 <p>Waschtischplatte inkl. Ausfräsung rechts</p> <p><i>Washbasin plate with notch right</i></p>	120,0	4,0	48,5	WTPP12R		607
 <p>Waschtisch-Unterschrank, Waschtisch links 1 Schubkasten</p> <p><i>washbasin base cabinet, washbasin left 1 drawer</i></p>	117,0	23,8	47,8	GWPWS11L		862
 <p>Waschtisch-Unterschrank, Waschtisch rechts 1 Schubkasten</p> <p><i>washbasin base cabinet, washbasin right 1 drawer</i></p>	117,0	23,8	47,8	GWPWS11R		862
 <p>Waschtisch-Unterschrank, Waschtisch links 2 Schubkästen</p> <p><i>washbasin base cabinet, washbasin left 2 drawers</i></p>	117,0	36,6	47,8	GWPWSS11L		1197
 <p>Waschtisch-Unterschrank, Waschtisch rechts 2 Schubkästen</p> <p><i>washbasin base cabinet, washbasin right 2 drawers</i></p>	117,0	36,6	47,8	GWPWSS11R		1197
 <p>Waschtisch-Unterschrank, Waschtisch links 1 Schubkasten, 1 Auszug</p> <p><i>washbasin base cabinet, washbasin left 1 drawer, 1 extension</i></p>	117,0	47,8	47,8	GWPWSA11L		1437
 <p>Waschtisch-Unterschrank, Waschtisch rechts 1 Schubkasten, 1 Auszug</p> <p><i>washbasin base cabinet, washbasin right 1 drawer, 1 extension</i></p>	117,0	47,8	47,8	GWPWSA11R		1437

3390 »120 cm POCO L und R/ 120 cm POCO L and R«

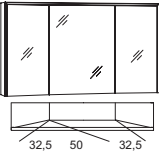
Beschreibung Description	Maße in cm Dimensions in cm			Artikel-Nr. Article no.	Türanschlag Door stop	Identnummer ID number
	B/W	H	T/D			
 <p>Waschtisch-Unterschrank, Waschtisch links 2 Schubkästen, 1 Auszug</p> <p><i>washbasin base cabinet, washbasin left 2 drawers, 1 extension</i></p>	117,0	60,6	47,8	GWPWSSA11L		PG1 Dickkante/ <i>thick edge</i> 1724
 <p>Waschtisch-Unterschrank, Waschtisch rechts 2 Schubkästen, 1 Auszug</p> <p><i>washbasin base cabinet, washbasin right 2 drawers, 1 extension</i></p>	117,0	60,6	47,8	GWPWSSA11R		1724
 <p>Spiegelschrank, 2 vollflächig verspiegelte Türen, 4 Glaseinlegeböden, seitliche LED-Beleuchtung 12,4 W, 6000 Kelvin inkl. Schalter/Steckdose EEK A-A++</p> <p><i>mirror cabinet, 2 full mirrored doors 4 glass boards, lateral LED-lighting 12,4 W, 6000 Kelvin incl. switch/socket EEC A-A++</i></p>	120	68,2	17,6	SADA12D		1687
 <p>LED-Aufbauleuchte für Spiegelschrank mit LED-Mini-Stecker, 16,6 W, 6000 Kelvin, ohne Schalter, EEK A-A++</p> <p><i>LED-lighting for mirror cabinet with LED-mini-plug, 16,6 W, 6000 Kelvin, without switch, EEC A-A++</i></p>	120	2,4	20	AW120		522
 <p>Spiegelschrank, 3 Spiegeltüren davon 2 trapezförmig angeordnet, 6 Glasein- legeböden, seitlich und oben LED- Beleuchtung, 23,6 W, 6000 Kelvin, inkl. Schalter/Steckdose, EEK A-A++</p> <p><i>mirror cabinet, 3 mirror doors, 2 of them are arranged in a trapeze, 6 glass shelves, lateral and top LED lighting 23,6 W, 6000 Kelvin incl. switch/socket, EEC A-A++</i></p>	120	68,2	17,5	SDU12		2251
 <p>Spiegelpaneel, Sensorschalter seitliche LED-Beleuchtung 2x 6,2 W 6000 Kelvin, EEK A-A++</p> <p><i>mirror panel, sensor switch lateral LED-lighting 2x 6,2 W 6000 Kelvin, EEC A-A++</i></p>	120	68,2	2,8	SPBSA12	 	1144
 <p>LED-Aufbauleuchte für Spiegelpaneel mit LED-Mini-Stecker, 16,9 W, 6000 Kelvin, ohne Schalter, EEK A-A++</p> <p><i>LED-lighting for mirror panel with LED-mini-plug, 16,9 W, 6000 Kelvin, without switch, EEC A-A++</i></p>	120	2,4	10	AWP120		398

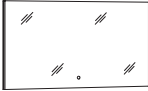
EEK/EEC=Energieeffizienzklasse/energy efficiency category







Beschreibung Description	Maße in cm Dimensions in cm			Artikel-Nr. Article no.	Türanschlag Door stop	Identnummer ID number
	B/W	H	T/D			
 <p>Aufsatz-Keramik-Washbecken inkl. Überlauf</p> <p><i>on-top ceramic washbasin incl. overflow</i></p>	56,0	15,0	38,0	KWPOC55		623
						
 <p>Waschtischkonsole Stahlrohr 4 x 4 cm, erforderlich</p> <p><i>washbasin mounting bracket steel 4 x 4 cm, required</i></p>	4,0	4,0	39,2	WK		134
						PG1 Dickkante/ <i>thick edge</i>
 <p>Waschtischplatte ohne Ausfräsung</p> <p><i>Washbasin plate without notch</i></p>	120,0	4,0	48,5	WTP12		572
 <p>Waschtischplatte inkl. Ausfräsung mittig</p> <p><i>Washbasin plate with central notch</i></p>	120,0	4,0	48,5	WTPP12M		607
 <p>Waschtisch-Unterschrank 1 Schubkasten</p> <p><i>washbasin base cabinet 1 drawer</i></p>	117,0	23,8	47,8	GWPWS11M		862
 <p>Waschtisch-Unterschrank 2 Schubkästen</p> <p><i>washbasin base cabinet 2 drawers</i></p>	117,0	36,6	47,8	GWPWS11M		1197
 <p>Waschtisch-Unterschrank 1 Schubkasten, 1 Auszug</p> <p><i>washbasin base cabinet 1 drawer, 1 extension</i></p>	117,0	47,8	47,8	GWPWSA11M		1437
 <p>Waschtisch-Unterschrank 2 Schubkästen, 1 Auszug</p> <p><i>washbasin base cabinet 2 drawers, 1 extension</i></p>	117,0	60,6	47,8	GWPWSSA11M		1724

Beschreibung Description	Maße in cm Dimensions in cm			Artikel-Nr. Article no.	Türanschlag Door stop	Identnummer ID number
	B/W	H	T/D			
 <p>Spiegelschrank, 3 vollflächig verspiegelte Türen, 6 Glaseinlegeböden, seitliche LED-Beleuchtung 12,4 W, 6000 Kelvin inkl. Schalter/Steckdose EEK A–A++</p> <p><i>mirror cabinet, 3 full mirrored doors, 6 glass boards, lateral LED-lighting 12,4 W, 6000 Kelvin incl. switch/socket EEC A–A++</i></p>	120	68,2	17,6	SADA12		1934
 <p>LED-Aufbauleuchte für Spiegelschrank mit LED-Mini-Stecker, 16,6 W, 6000 Kelvin, ohne Schalter, EEK A–A++</p> <p><i>LED-lighting for mirror cabinet with LED-mini-plug, 16,6 W, 6000 Kelvin, without switch, EEC A–A++</i></p>	120	2,4	20	AW120		522
 <p>Spiegelschrank, 3 Spiegeltüren davon 2 trapezförmig angeordnet, 6 Glaseinlegeböden, seitlich und oben LED-Beleuchtung, 23,6 W, 6000 Kelvin, inkl. Schalter/Steckdose, EEK A–A++</p> <p><i>mirror cabinet, 3 mirror doors, 2 of them are arranged in a trapeze, 6 glass shelves, lateral and top LED lighting 23,6 W, 6000 Kelvin incl. switch/socket, EEC A–A++</i></p>	120	68,2	17,5	SDU12		2251
 <p>Spiegelpaneel, Sensorschalter seitliche LED-Beleuchtung 2x 6,2 W 6000 Kelvin, EEK A–A++</p> <p><i>mirror panel, sensor switch lateral LED-lighting 2x 6,2 W 6000 Kelvin, EEC A–A++</i></p>	120	68,2	2,8	SPBSA12	 	1144
 <p>LED-Aufbauleuchte für Spiegelpaneel mit LED-Mini-Stecker, 16,9 W, 6000 Kelvin, ohne Schalter, EEK A–A++</p> <p><i>LED-lighting for mirror panel with LED-mini-plug, 16,9 W, 6000 Kelvin, without switch, EEC A–A++</i></p>	120	2,4	10	AWP120		398

EEK/EEC=Energieeffizienzklasse/energy efficiency category

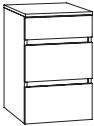

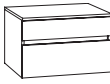
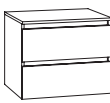





3390 »Unterschränke mit Abdeckplatte/base cabinets with cover plaid«

Beschreibung Description	Maße in cm Dimensions in cm			Artikel-Nr. Article no.	Türanschlag Door stop	Identnummer ID number
	B/W	H	T/D			

						PG1 Dickkante/thick edge
	Unterschrank inkl. Abdeckplatte 1 Auszug <i>base cabinet incl. top 1 extension</i>	40,0	25,6	48,5	GUWA4F	707
	Unterschrank inkl. Abdeckplatte 1 Schubkasten, 1 Auszug <i>base cabinet incl. top 1 drawer, 1 extension</i>	40,0	38,4	48,5	GUWSA4F	930
	Unterschrank inkl. Abdeckplatte 2 Auszüge <i>base cabinet incl. top 2 extensions</i>	40,0	49,6	48,5	GUWAA4F	1005
	Unterschrank inkl. Abdeckplatte 1 Schubkasten, 2 Auszüge <i>sideboard incl. top 1 drawer, 2 extensions</i>	40,0	62,4	48,5	GUWSAA4F	1279
	i Unterschrank inkl. Abdeckplatte 1 Schubkasten, 1 Einschubregal, 1 Auszug <i>sideboard incl. top 1 drawer, 1 push-in shelf, 1 extension</i>	40,0	62,4	48,5	GUWSEA4F	1154
	Unterschrank inkl. Abdeckplatte 1 Auszug <i>base cabinet incl. top 1 extension</i>	60,0	25,6	48,5	GUWA6F	756
	Unterschrank inkl. Abdeckplatte 1 Schubkasten, 1 Auszug <i>base cabinet incl. top 1 drawer, 1 extension</i>	60,0	38,4	48,5	GUWSA6F	1080
	Unterschrank inkl. Abdeckplatte 2 Auszüge <i>base cabinet incl. top 2 extensions</i>	60,0	49,6	48,5	GUWAA6F	1129
	Unterschrank inkl. Abdeckplatte 1 Schubkasten, 2 Auszüge <i>sideboard incl. top 1 drawer, 2 extensions</i>	60,0	62,4	48,5	GUWSAA6F	1353
	i Unterschrank inkl. Abdeckplatte 1 Schubkasten, 1 Einschubregal, 1 Auszug <i>sideboard incl. top 1 drawer, 1 push-in shelf, 1 extension</i>	60,0	62,4	48,5	GUWSEA6F	1328







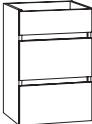

i Regalfarben unbedingt mit angeben, Übersicht siehe Seite 3. *Please indicate shelf colours, overview see page 3.*

3390 »Unterschranke mit Abdeckplatte/base cabinets with cover plaid«

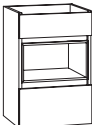
Beschreibung Description	Maße in cm Dimensions in cm			Artikel-Nr. Article no.	Türanschlag Door stop	Identnummer ID number
	B/W	H	T/D			
	Unterschrank inkl. Abdeckplatte 1 Auszug <i>base cabinet incl. top 1 extension</i>	97,0	25,6	48,5	GUWA9F	PG1 Dickkante/thick edge 881
	Unterschrank inkl. Abdeckplatte 1 Schubkasten, 1 Auszug <i>base cabinet incl. top 1 drawer, 1 extension</i>	97,0	38,4	48,5	GUWSA9F	1179
	Unterschrank inkl. Abdeckplatte 2 Auszüge <i>base cabinet incl. top 2 extensions</i>	97,0	49,6	48,5	GUWAA9F	1353
	Unterschrank inkl. Abdeckplatte 1 Schubkasten, 2 Auszüge <i>base cabinet incl. top 1 drawer, 2 extensions</i>	97,0	62,4	48,5	GUWSAA9F	1602
	Unterschrank inkl. Abdeckplatte 1 Auszug <i>base cabinet incl. top 1 extension</i>	117,0	25,6	48,5	GUWA11F	1005
	Unterschrank inkl. Abdeckplatte 1 Schubkasten, 1 Auszug <i>base cabinet incl. top 1 drawer, 1 extension</i>	117,0	38,4	48,5	GUWSA11F	1254
	Unterschrank inkl. Abdeckplatte 2 Auszüge <i>base cabinet incl. top 2 extensions</i>	117,0	49,6	48,5	GUWAA11F	1453
	Unterschrank inkl. Abdeckplatte 1 Schubkasten, 2 Auszüge <i>base cabinet incl. top 1 drawer, 2 extensions</i>	117,0	62,4	48,5	GUWSAA11F	1726

3390 »Unterschränke ohne Abdeckplatte/base cabinets without cover plaid«

Beschreibung Description	Maße in cm Dimensions in cm			Artikel-Nr. Article no.	Türanschlag Door stop	Identnummer ID number
	B/W	H	T/D			

						PG1 Dickkante/thick edge	
	Unterschrank ohne Abdeckplatte 1 Schubkasten, 2 Auszüge <i>base cabinet without top 1 drawer, 2 extensions</i>	40,0	60,6	35,0	GUHSAA4	1149	
		Unterschrank ohne Abdeckplatte 1 Schubkasten, 1 Einschubregal, 1 Auszug <i>base cabinet without top 1 drawer, 1 push-in shelf, 1 extension</i>	40,0	60,6	35,0	GUHSEA4	1054
	Unterschrank ohne Abdeckplatte 1 Schubkasten, 2 Auszüge <i>base cabinet without top 1 drawer, 2 extensions</i>	60,0	60,6	35,0	GUHSAA6	1293	
		Unterschrank ohne Abdeckplatte 1 Schubkasten, 1 Einschubregal, 1 Auszug <i>base cabinet without top 1 drawer, 1 push-in shelf, 1 extension</i>	60,0	60,6	35,0	GUHSEA6	1269
	Unterschrank ohne Abdeckplatte 1 Schubkasten, 2 Auszüge <i>base cabinet without top 1 drawer, 2 extensions</i>	97,0	60,6	35,0	GUHSAA9	1533	
	Unterschrank ohne Abdeckplatte 1 Schubkasten, 2 Auszüge <i>base cabinet without top 1 drawer, 2 extensions</i>	117,0	60,6	35,0	GUHSAA11	1700	

						PG1 Dickkante/thick edge
	Maßvariable Abdeckplatte für Unterschränke ohne Abdeckplatte <i>cover panel in variable dimensions for base cabinets without top</i>	117,0 max.	1,6	49,3 max.	ADFV	192





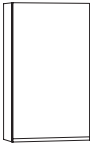
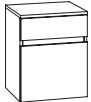
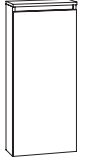
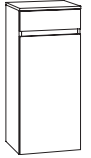
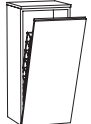
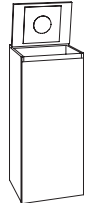
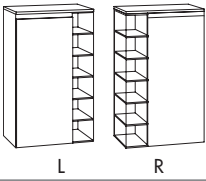
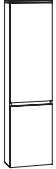

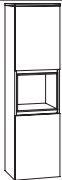

 Regalfarben unbedingt mit angeben, Übersicht siehe Seite 3. *Please indicate shelf colours, overview see page 3.*

3390 »Beistellschränke/ side cabinets«

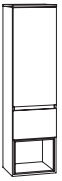
	Beschreibung Description	Maße in cm Dimensions in cm			Artikel-Nr. Article no.	Türanschlag Door stop	Identnummer ID number
		B/W	H	T/D			
	Oberschrank 1 Tür 2 Glaseinlegeböden <i>top cabinet 1 door 2 glass boards</i>	40	68,2	17,4	GOT40DL GOT40DR GOLT4L GOLT4R	Links/ <i>left</i> Rechts/ <i>right</i> Links/ <i>left</i> Rechts/ <i>right</i>	PG1 Dickkante/ <i>thick edge</i> 498
	Unterschrank inkl. Abdeckplatte 1 Tür, 1 Schubkasten <i>base cabinet incl. top 1 door, 1 drawer</i>	40	49,6	34,8	GUST4FL GUST4FR	Links/ <i>left</i> Rechts/ <i>right</i>	722
	Highboard inkl. Abdeckplatte 1 Tür 2 Glaseinlegeböden <i>high cabinet incl. top 1 door 2 glass boards</i>	40	91,2	17,4	GHBFT4FL GHBFT4FR GHBT4FL GHBT4FR	Links/ <i>left</i> Rechts/ <i>right</i> Links/ <i>left</i> Rechts/ <i>right</i>	608
	Highboard inkl. Abdeckplatte 1 Tür, 1 Schubkasten 2 Glaseinlegeböden <i>high cabinet incl. top 1 door, 1 drawer 2 glass boards</i>	40	91,2	34,8	GHBST4FL GHBST4FR	Links/ <i>left</i> Rechts/ <i>right</i>	905
	Highboard inkl. Abdeckplatte 1 Tür/Wäschekippe <i>high cabinet incl. top 1 door/linen bin</i>	40	91,2	34,8	GHBW4F		714
	Schminkschrank inkl. Deckel 1 Tür, 1 Klappe 2 Glaseinlegeböden Kosmetikeinsatz & Vergrößerungsspiegel <i>make-up cabinet incl. lid 1 door, 1 flap door 2 glass boards cosmetic insert part & magnifying mirror</i>	40	91,2	34,8	GHBKT4L GHBKT4R	Links/ <i>left</i> Rechts/ <i>right</i>	970
	Highboard inkl. Abdeckplatte 1 Tür, 2 Glaseinlegeböden 1 seitliches Glasregal, 5 Glasböden <i>high cabinet incl. top 1 door, 2 glass boards 1 lateral glass shelf, 5 glass boards</i>	55	91,2	34,8	GHBTR55FL GHBTR55FR	Links/ <i>left</i> Rechts/ <i>right</i>	2836
	Mittelschrank inkl. Abdeckplatte 2 Türen 3 Glaseinlegeböden <i>medium cabinet incl. top 2 doors 3 glass boards</i>	40	148,8	17,4	GMFTT4FL GMFTT4FR GMITT4FL GMITT4FR	Links/ <i>left</i> Rechts/ <i>right</i> Links/ <i>left</i> Rechts/ <i>right</i>	982

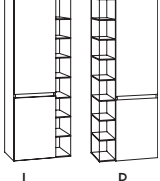

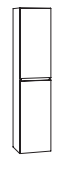



3390 »Beistellschränke/side cabinets«

Beschreibung Description	Maße in cm Dimensions in cm			Artikel-Nr. Article no.	Türanschlag Door stop	Identnummer ID number
	B/W	H	T/D			

						PG1 Dickkante/ thick edge		
		Mittelschrank inkl. Abdeckplatte 2 Türen, 1 Einschubregal 2 Glaseinlegeböden <i>medium cabinet incl. top 2 doors, 1 push-in shelf 2 glass boards</i>	40	148,8	34,8	GMTET4FL GMTET4FR	Links/ <i>left</i> Rechts/ <i>right</i>	1244
		Mittelschrank inkl. Abdeckplatte 1 Tür, 1 Auszug, 1 Einschubregal 2 Glaseinlegeböden <i>medium cabinet incl. top 1 door, 1 extension, 1 push-in shelf 2 glass boards</i>	40	148,8	34,8	GMTAE4FL GMTAE4FR	Links/ <i>left</i> Rechts/ <i>right</i>	1343
		Mittelschrank inkl. Abdeckplatte 2 Türen, 1 Schubkasten 3 Glaseinlegeböden <i>medium cabinet incl. top 2 doors, 1 drawer 3 glass boards</i>	40	148,8	34,8	GMTST4FL GMTST4FR	Links/ <i>left</i> Rechts/ <i>right</i>	1215
		Mittelschrank inkl. Abdeckplatte 1 Tür, 2 Auszüge 2 Glaseinlegeböden <i>medium cabinet incl. top 1 door, 2 extensions 2 glass boards</i>	40	148,8	34,8	GMTAA4FL GMTAA4FR	Links/ <i>left</i> Rechts/ <i>right</i>	1190
		Mittelschrank inkl. Abdeckplatte 2 Türen, 3 Glaseinlegeböden 1 seitl. Glasregal, 7 Glasböden <i>medium cabinet incl. top 2 doors, 3 glass boards 1 lateral glass shelf, 7 glass boards</i>	55	148,8	34,8	GMTGR55FL GMTGR55FR	Links/ <i>left</i> Rechts/ <i>right</i>	3582
		Glasregal inkl. Abdeckplatte 7 Glasböden <i>glass shelf incl. top 7 glass boards</i>	33,8	148,8	15	MGR33F		2587
		Hochschrank 2 Türen 4 Glaseinlegeböden <i>tower cabinet 2 doors 4 glass boards</i>	40	178,7	17,6	GHFTT4L GHFTT4R	Links/ <i>left</i> Rechts/ <i>right</i>	1034
			40	178,7	34,8	GHTT4L GHTT4R	Links/ <i>left</i> Rechts/ <i>right</i>	
		Hochschrank 2 Türen, 1 Einschubregal 4 Glaseinlegeböden <i>tower cabinet 2 doors, 1 push-in shelf 4 glass boards</i>	40	178,7	34,8	GHTET4L GHTET4R	Links/ <i>left</i> Rechts/ <i>right</i>	1364



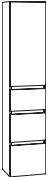
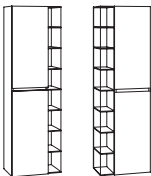





 Regalfarben unbedingt mit angeben, Übersicht siehe Seite 3. Please indicate shelf colours, overview see page 3.

3390 »Beistellschränke/ side cabinets«

Beschreibung Description	Maße in cm Dimensions in cm			Artikel-Nr. Article no.	Türanschlag Door stop	Identnummer ID number	
	B/W	H	T/D				
  <p>Hochschrank 1 Tür, 2 Auszüge, 1 Einschubregal 2 Glaseinlegeböden</p> <p><i>tower cabinet 1 door, 2 extensions, 1 push-in shelf 2 glass boards</i></p>	40	178,7	34,8	GHTAAE4L GHTAAE4R	Links/ <i>left</i> Rechts/ <i>right</i>	1592	
	 <p>Hochschrank 2 Türen, 1 Schubkasten 3 Glaseinlegeböden</p> <p><i>tower cabinet 2 doors, 1 drawer 3 glass boards</i></p>	40	178,7	34,8	GHTST4L GHTST4R	Links/ <i>left</i> Rechts/ <i>right</i>	1292
		 <p>Hochschrank 1 Tür, 1 Tür/Wäschekippe 2 Glaseinlegeböden</p> <p><i>tower cabinet 1 door, 1 door/linen bin 2 glass boards</i></p>	40	178,7	34,8	GHTW4L GHTW4R	Links/ <i>left</i> Rechts/ <i>right</i>
	 <p>Hochschrank 1 Tür, 3 Auszüge 2 Glaseinlegeböden</p> <p><i>tower cabinet 1 door, 3 extensions 2 glass boards</i></p>		40	178,7	34,8	GHTAAA4L GHTAAA4R	Links/ <i>left</i> Rechts/ <i>right</i>
		 <p>Hochschrank 2 Türen, 4 Glaseinlegeböden 1 seitl. Glasregal, 7 Glasböden</p> <p><i>tower cabinet 2 doors, 4 glass boards 1 lateral glass shelf, 7 glass boards</i></p> <p>L R</p>	55	178,7	34,8	GHTTGR55L GHTTGR55R	Links/ <i>left</i> Rechts/ <i>right</i>
Hochschrank mit Spiegeltür/ tower cabinet with mirrored door - FGQ							
 <p>Hochschrank 2 Spiegeltüren 4 Glaseinlegeböden</p> <p><i>tower cabinet 2 mirrored doors 4 glass boards</i></p>	40	178,7	34,8	HPP4L HPP4R	Links/ <i>left</i> Rechts/ <i>right</i>	1170	
	40	178,7	17,6	HFPP4L HFPP4R	Links/ <i>left</i> Rechts/ <i>right</i>		
 <p>Glasregal 7 Glasböden</p> <p><i>glass shelf 7 glass boards</i></p>	33,8	178,7	15	HGR33		2786	

 Regalfarben unbedingt mit angeben, Übersicht siehe Seite 3. *Please indicate shelf colours, overview see page 3.*





3390 »Regale/shelves«

Beschreibung Description	Maße in cm Dimensions in cm			Artikel-Nr. Article no.	Türanschlag Door stop	Identnummer ID number
	B/W	H	T/D			
<p>i Winkelablage unten mit satiniertem Glasboden für Spiegelschrank/Spiegelpaneel inkl. Aufhänger</p>  <p><i>Bottom angle shelf with frosted glass base for mirror cabinet/mirror panel, incl. hanging brackets</i></p>	45	15,8	12,6	SRP45		199
<p>i Winkelablage unten mit satiniertem Glasboden für Spiegelschrank/Spiegelpaneel inkl. Aufhänger</p>  <p><i>Bottom angle shelf with frosted glass base for mirror cabinet/mirror panel, incl. hanging brackets</i></p>	60	15,8	12,6	SRP6		230
<p>i Regal für Montage unter Spiegelschrank/Spiegelpaneel oder freihängend, inkl. Aufhänger</p>  <p><i>shelf for mounting under mirror cabinet/mirror panel or free-hanging, incl. hanging brackets</i></p>	45	17	15,6	SRB45		241
<p>i Regal für Montage unter Spiegelschrank/Spiegelpaneel oder freihängend, inkl. Aufhänger</p>  <p><i>shelf for mounting under mirror cabinet/mirror panel or free-hanging, incl. hanging brackets</i></p>	60	17	15,6	SRB6		267
<p>i Regal für Montage unter Spiegelschrank/Spiegelpaneel oder freihängend, inkl. Aufhänger</p>  <p><i>shelf for mounting under mirror cabinet/mirror panel or free-hanging, incl. hanging brackets</i></p>	80	17	15,6	SRB8		297
<p>i Regal für Montage unter Spiegelschrank/Spiegelpaneel oder freihängend, inkl. Aufhänger</p>  <p><i>shelf for mounting under mirror cabinet/mirror panel or free-hanging, incl. hanging brackets</i></p>	90	17	15,6	SRB9		313
<p>i Regal für Montage unter Spiegelschrank/Spiegelpaneel oder freihängend, inkl. Aufhänger</p>  <p><i>shelf for mounting under mirror cabinet/mirror panel or free-hanging, incl. hanging brackets</i></p>	100	17	15,6	SRB10		327
<p>i Regal für Montage unter Spiegelschrank/Spiegelpaneel oder freihängend, inkl. Aufhänger</p>  <p>60 cm 60 cm <i>shelf for mounting under mirror cabinet/mirror panel or free-hanging, incl. hanging brackets</i></p>	120	17	15,6	SRB12-66		378

Alle Regale sind inkl. Aufhänger, Montage ist horizontal und vertikal möglich / all shelves are incl. hanging brackets, mounting is possible horizontally and vertically.

i Regalfarben unbedingt mit angeben, Übersicht siehe Seite 3. Please indicate shelf colours, overview see page 3.









Beschreibung Description	Maße in cm Dimensions in cm			Artikel-Nr. Article no.	Türanschlag Door stop	Identnummer ID number
	B/W	H	T/D			

 	Regal für seitliche Montage oder freihängend, inkl. Aufhänger <i>shelf for side mounting or free-hanging incl. hanging brackets</i>	15	68,2	15,6	REB15		320
 	Regal für seitliche Montage oder freihängend, inkl. Aufhänger <i>shelf for side mounting or free-hanging incl. hanging brackets</i>	20	68,2	15,6	REB20		343

Alle Regale sind inkl. Aufhänger, Montage ist horizontal und vertikal möglich / *all shelves are incl. hanging brackets, mounting is possible horizontally and vertically.*

 Regalfarben unbedingt mit angeben, Übersicht siehe Seite 3. *Please indicate shelf colours, overview see page 3.*

Beschreibung Description	Maße in cm Dimensions in cm			Artikel-Nr. Article no.	Türanschlag Door stop	Identnummer ID number
	B/W	H	T/D			

	Handtuchhalter 1-armig (Befestigung am Schrank) <i>towel rail 1-arm (fastening on the cabinet)</i>	5	1	33	HHF133		85
	Handtuchhalter 1-armig (Befestigung am Schrank) ausziehbar <i>towel rail 1-arm (fastening on the cabinet) pull out</i>	7,5	4	32,5/ 50	HH133		112
	Handtuchhalter 2-armig (Befestigung am Schrank) ausziehbar <i>towel rail 2-arms (fastening on the cabinet) pull out</i>	10,5	4	32,5/ 50	HH233		141
	Handtuchhalter verchromt (Befestigung am Schrank) <i>chromed towel rail (fastening on the cabinet)</i>	5	2,5	40	RHH		189
	Spiegelschrank-Unterbaubeleuchtung 5,8 W LED EEK A–A++ (für Spiegelschrank ab 60 cm Breite), 6000 Kelvin Beleuchtung kann unter Spiegel- schränken und unter Regalen verbaut werden. <i>base lighting for mirror cabinet 5,8 W LED EEC A–A++ (for mirror cabinet ex 60 cm width), 6000 Kelvin Lighting can be installed under mirror cabinets and under shelves.</i>	57			WTBP60		289
	Spiegelschrank-Unterbaubeleuchtung 3,4 W LED EEK A–A++ (für Spiegel- schrank ab 80 cm Breite) 6000 Kelvin Beleuchtung kann nur unter Spiegel- schränke und nicht unter Regale verbaut werden. <i>base lighting for mirror cabinet 3,4 W LED EEC A–A++ (for mirror cabinet ex 80 cm width) 6000 Kelvin Lighting only can be installed under mirror cabinets and not under shelves.</i>	70	2	1,5	WTB70		265
	Spiegelschrank-Unterbaubeleuchtung 5,3 W LED EEK A–A++ (für Spiegelschrank ab 120 cm Breite) 6000 Kelvin Beleuchtung kann nur unter Spiegel- schränke und nicht unter Regale verbaut werden. <i>base lighting for mirror cabinet 5,3 W LED EEC A–A++ (for mirror cabinet ex 120 cm width) 6000 Kelvin Lighting only can be installed under mirror cabinets and not under shelves.</i>	110	2	1,5	WTB110		382

EEK/EEC=Energieeffizienzklasse/energy efficiency category

Beschreibung Description	Maße in cm Dimensions in cm			Artikel-Nr. Article no.	Türanschlag Door stop	Identnummer ID number
	B/W	H	T/D			
 <p>Waschtischunterschrankbeleuchtung 6,7 W LED, 4000/4500/6000 Kelvin umschalbar in 3 Lichtfarben, EEK A-A++ inkl. Schalter, für Unterschrank ab 80 cm Breite</p> <p><i>base lighting for washbasin cabinet 6,7 W LED, 4000/4500/600 Kelvin 3 switchable luminous colours EEC A-A++, incl. switch, for base cabinet ex 80 cm width</i></p>	70	2	1,5	WUTB72		307
 <p>Schubkasteneinsatz (Kunststoff) für Schubkasten 40 cm B: 40 cm / T: 30 cm für Beistellschränke</p> <p><i>drawer insert part (plastic) for drawer 40 cm w: 40cm / d: 30 cm for side cabinets</i></p>	30,9	4,5	28	SEG4		66
 <p>Schubkasteneinsatz (Kunststoff) für Schubkasten 40 cm B: 40 cm / T: 40 cm für Waschtischunterschranke</p> <p><i>drawer insert part (plastic) for drawer 40 cm w: 40cm / d: 40 cm for washbasin base cabinets</i></p>	30,9	4,5	38	SEG44		75
 <p>Schubkasteneinsatz (Kunststoff) für Schubkasten 60 cm B: 60 cm / T: 30 cm für Beistellschränke</p> <p><i>drawer insert part (plastic) for drawer 60 cm w: 60cm / d: 30 cm for side cabinets</i></p>	50,9	4,5	28	SEG6		101
 <p>Schubkasteneinsatz (Kunststoff) für Schubkasten 60 cm B: 60 cm / T: 40 cm für Waschtischunterschranke</p> <p><i>drawer insert part (plastic) for drawer 60 cm w: 60cm / d: 40 cm for washbasin base cabinets</i></p>	50,9	4,5	38	SEG64		110
 <p>Schubkasteneinsatz (Kunststoff) für oberen Auszug vom WT-Unterschrank</p> <p><i>drawer insert part (plastic) for top drawer from base cabinet</i></p>	33,7	4,3	28	SABEG3		59

EEK/EEC=Energieeffizienzklasse/energy efficiency category

	Beschreibung <i>Description</i>	Maße in cm <i>Dimensions in cm</i>			Artikel-Nr. <i>Article no.</i>	Türanschlag <i>Door stop</i>	Identnummer <i>ID number</i>
		B/W	H	T/D			
	Inneneinteilung für 77 cm Auszug <i>internal subdivision for 77 cm extension</i>	75	6	1,1	IEG77		139
	Inneneinteilung für 97 cm Auszug <i>internal subdivision for 97 cm extension</i>	95	6	1,1	IEG97		159
	Inneneinteilung für 117 cm Auszug <i>internal subdivision for 117 cm extension</i>	115	6	1,1	IEG117		180
	Designsiphon <i>design siphon</i>				DS		229
	Raumsparsiphon <i>basin siphon</i>				RSPAR-4		86
	Stellfuß verchromt 5x5 cm, 2-er Set Höhenverstellung +1 cm für Schrankhöhe 47,8 cm <i>adjustable feet chromed 5x5 cm, set of 2, adjustment range +1 cm for cabinet height 47,8 cm</i>		24,2		SFA4		159
	Stellfuß verchromt 5x5 cm, 2-er Set Höhenverstellung +1 cm für Schrankhöhe 60,6 cm <i>adjustable feet chromed 5x5 cm, set of 2, adjustment range +1 cm for cabinet height 60,6 cm</i>		10		SFB4		115
	Sockelstellfuß Chrom je 4 Stück/Pack <i>adjustable feet chromated 4 pcs/unit</i>		12/ 14		SF12C		65
	Waschtischkonsole Stahlrohr 4 x 4 cm <i>washbasin mounting bracket steel 4 x 4 cm</i>	4	4	39,2	WK		134
	Befestigungsmaterial für Keramik- und Mineralmarmor Waschtische M14 <i>Mounting set for ceramic and mineral marble washbasins M14</i>				MONK-4		64
	Spiegelheizung für Spiegelpaneel 35 W inkl. Schalter <i>mirror heater for mirror panel 35 W incl. switch</i>	50	30		SH		500

3390 »Maße/dimensions«

Bohrlochhöhen für Schraubhaken, Anschlussmaße und Abflusshöhen/drilling point for screw hooks, dimensions for mounting and drain

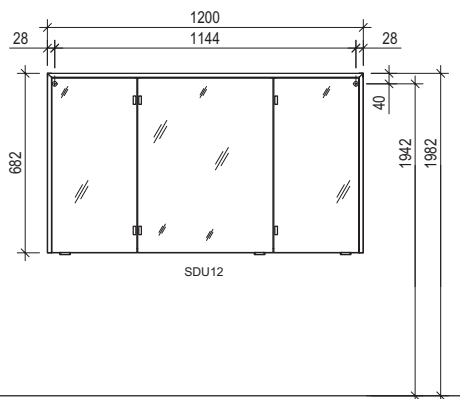
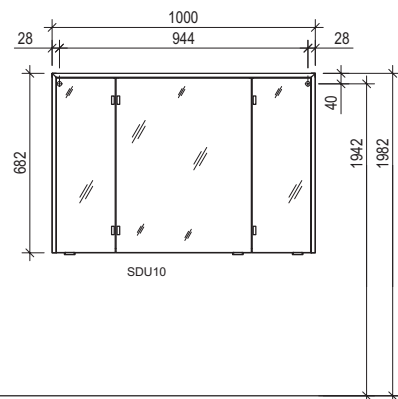
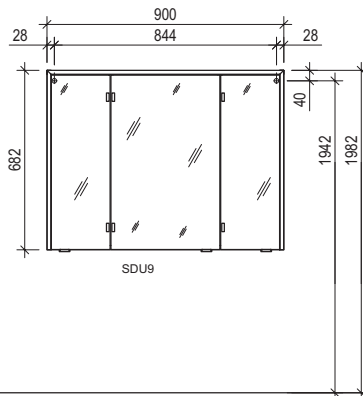
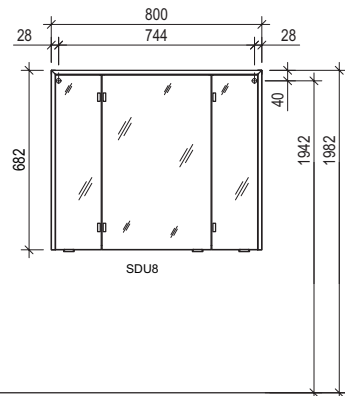
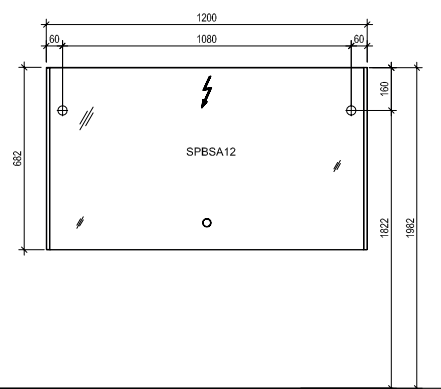
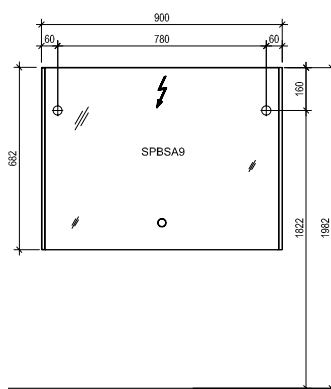
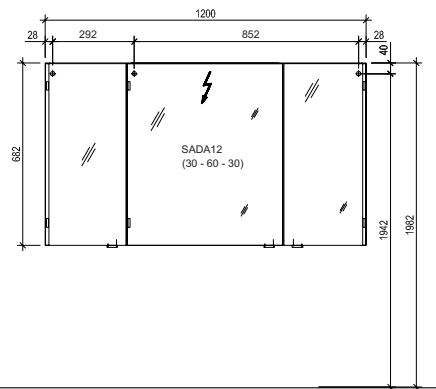
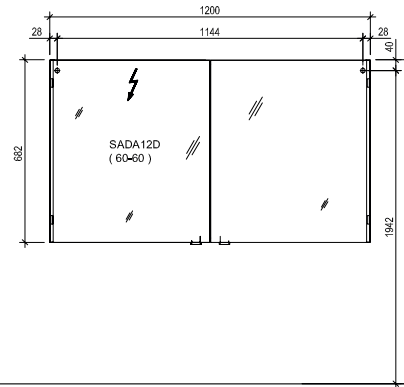
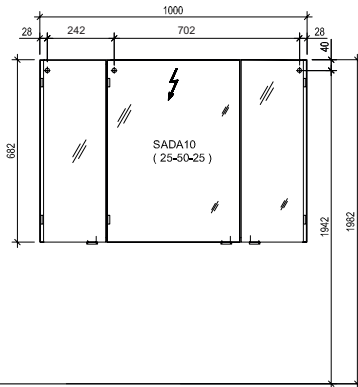
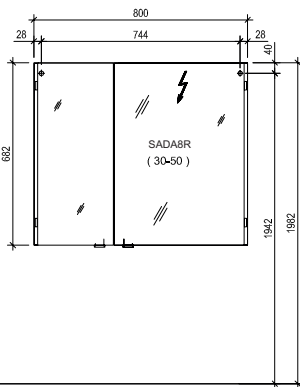

Achtung: Die Montage muss durch fachkundige Personen erfolgen. Der Untergrund zur Wandbefestigung ist vor Montage zu prüfen. Bitte wählen Sie entsprechend das geeignete Befestigungsmaterial. Fehlerhafte Montagen können das Möbel beschädigen oder dessen Funktion dauerhaft beeinträchtigen. Für Sach- und Personenschäden übernehmen wir im Falle einer unsachgemäßen Montage keine Haftung.

Attention: Assembly must be carried out by skilled personnel. The subsurface for the wall mounting must be checked before assembly. Please select a suitable mounting material. Faulty assembly can damage furniture or permanently impair its function. We will not be held responsible for damage to material or persons in the case of improper assembly.

3390 »Maße/dimensions«

Bohrlochhöhen für Schraubhaken, Anschlussmaße und Abflusshöhen/drilling point for screw hooks, dimensions for mounting and drain

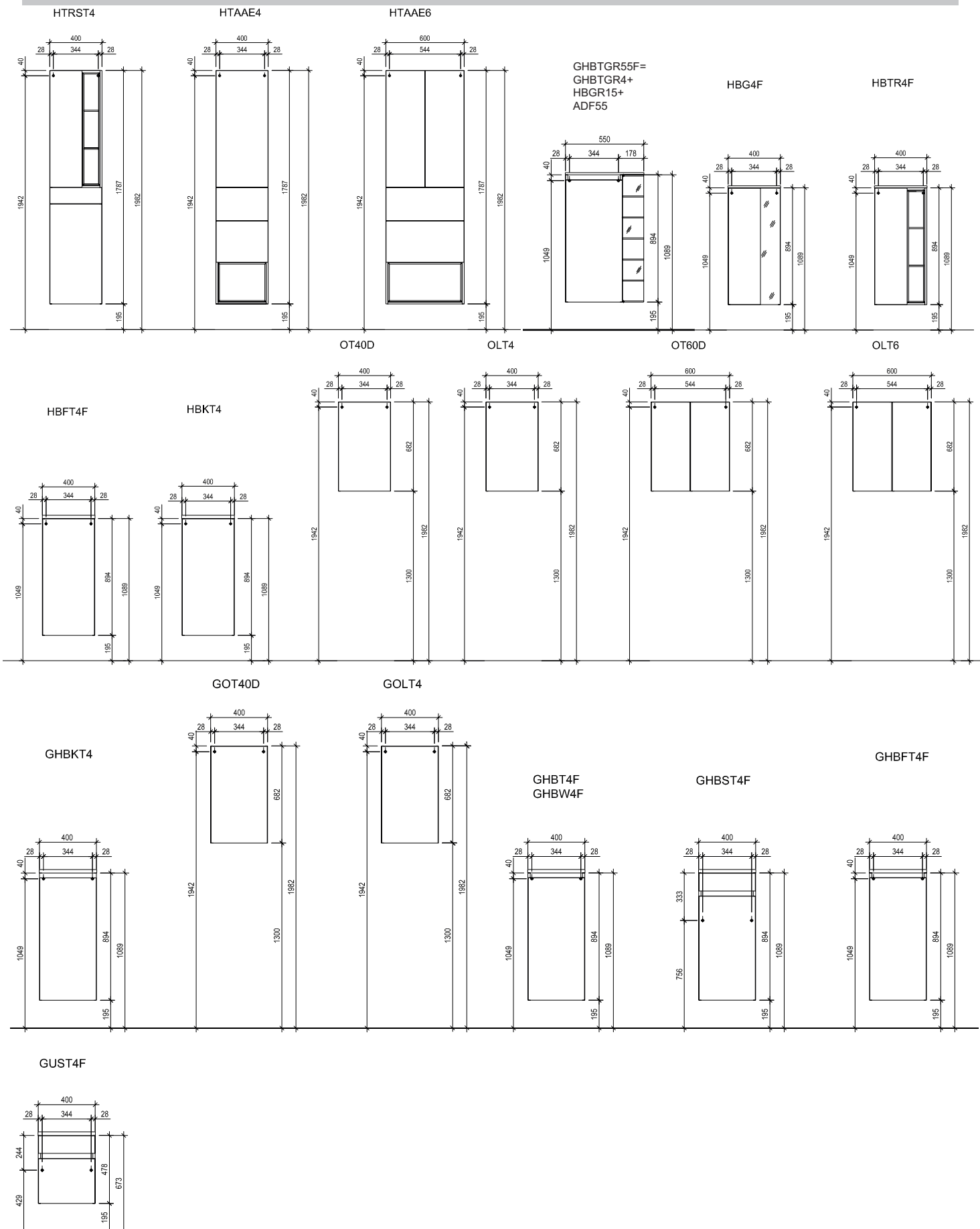

! Achtung: Die Montage muss durch fachkundige Personen erfolgen. Der Untergrund zur Wandbefestigung ist vor Montage zu prüfen. Bitte wählen Sie entsprechend das geeignete Befestigungsmaterial. Fehlerhafte Montagen können das Möbel beschädigen oder dessen Funktion dauerhaft beeinträchtigen. Für Sach- und Personenschäden übernehmen wir im Falle einer unsachgemäßen Montage keine Haftung.
 Attention: Assembly must be carried out by skilled personnel. The subsurface for the wall mounting must be checked before assembly. Please select a suitable mounting material. Faulty assembly can damage furniture or permanently impair its function. We will not be held responsible for damage to material or persons in the case of improper assembly.

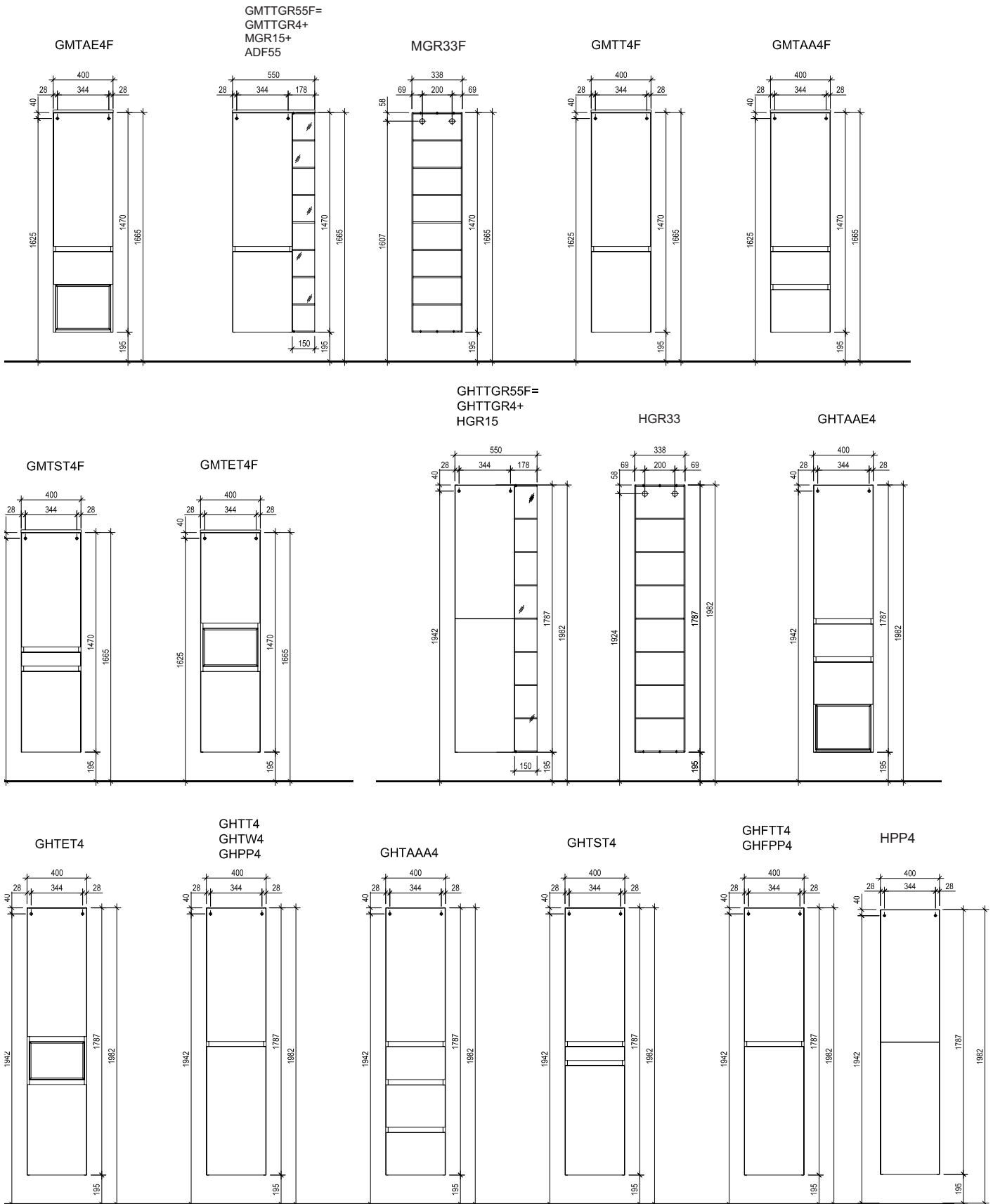

Achtung: Die Montage muss durch fachkundige Personen erfolgen. Der Untergrund zur Wandbefestigung ist vor Montage zu prüfen. Bitte wählen Sie entsprechend das geeignete Befestigungsmaterial. Fehlerhafte Montagen können das Möbel beschädigen oder dessen Funktion dauerhaft beeinträchtigen. Für Sach- und Personenschäden übernehmen wir im Falle einer unsachgemäßen Montage keine Haftung.
Attention: Assembly must be carried out by skilled personnel. The subsurface for the wall mounting must be checked before assembly. Please select a suitable mounting material. Faulty assembly can damage furniture or permanently impair its function. We will not be held responsible for damage to material or persons in the case of improper assembly.

INGA/WTP18M

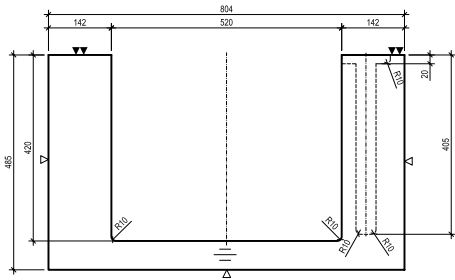

INGA/WTP110M

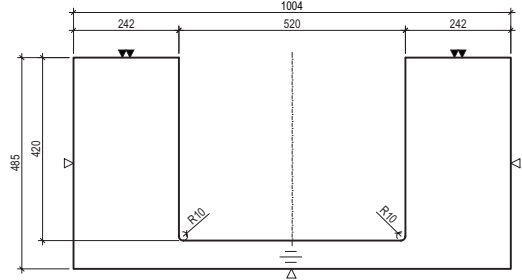

INGA/WTP112L

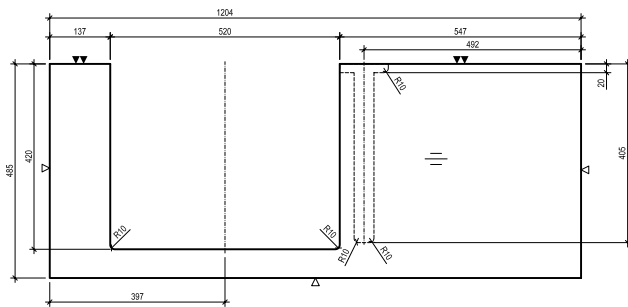

INGA/WTP112M

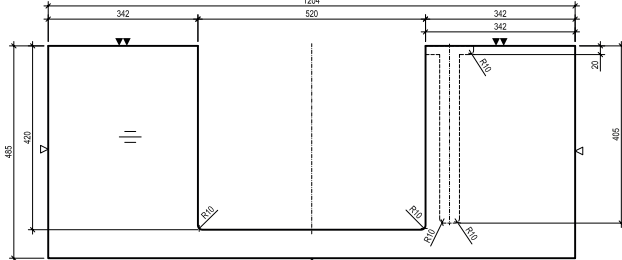

INGA/WTP112R

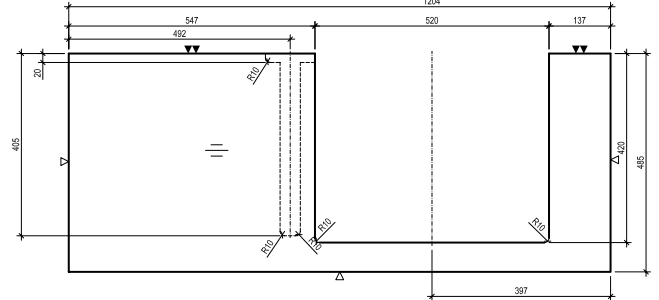

BELLA/WTPB8M

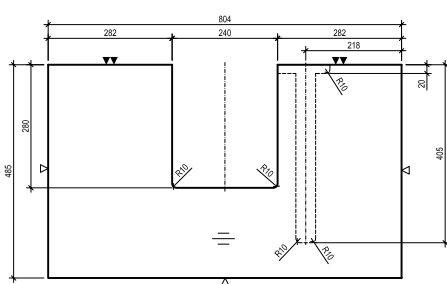

BELLA/WTPB10M

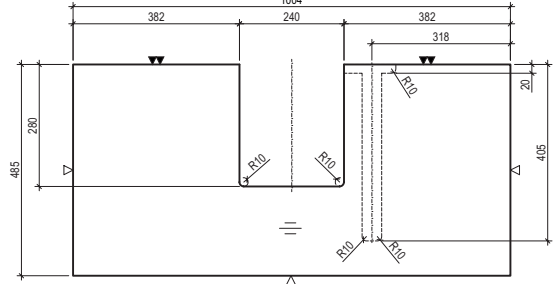

BELLA/WTPB12L

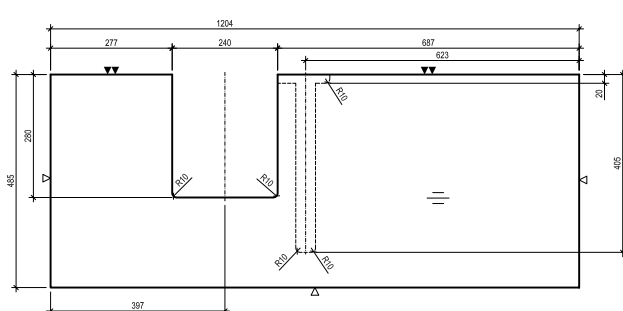

! Achtung: Die Montage muss durch fachkundige Personen erfolgen. Der Untergrund zur Wandbefestigung ist vor Montage zu prüfen. Bitte wählen Sie entsprechend das geeignete Befestigungsmaterial. Fehlerhafte Montagen können das Möbel beschädigen oder dessen Funktion dauerhaft beeinträchtigen. Für Sach- und Personenschäden übernehmen wir im Falle einer unsachgemäßen Montage keine Haftung.
 Attention: Assembly must be carried out by skilled personnel. The subsurface for the wall mounting must be checked before assembly. Please select a suitable mounting material. Faulty assembly can damage furniture or permanently impair its function. We will not be held responsible for damage to material or persons in the case of improper assembly.

BELLA/WTPB12M

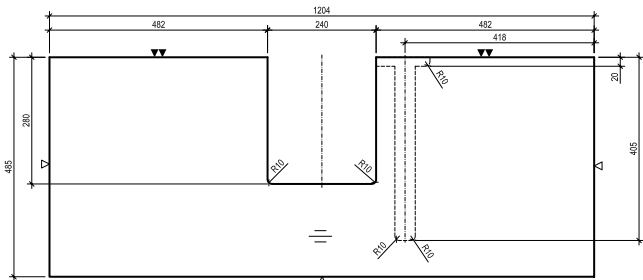

BELLA/WTPB12R

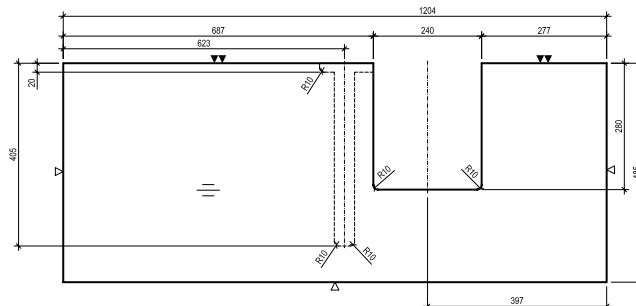

POCO/WTPP8M

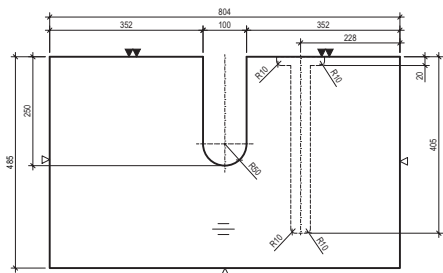

POCO/WTPP10M

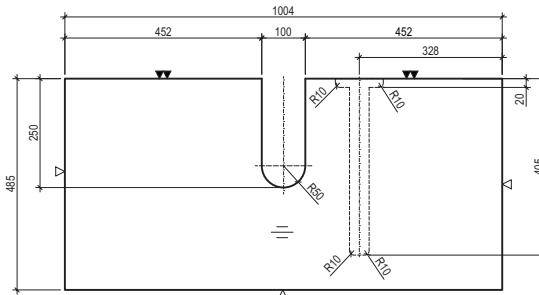

POCO/WTPP12L

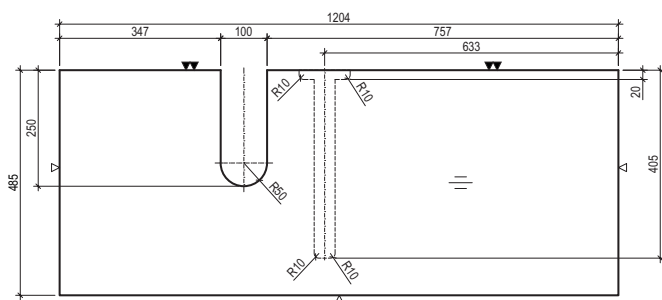

POCO/WTPP12M

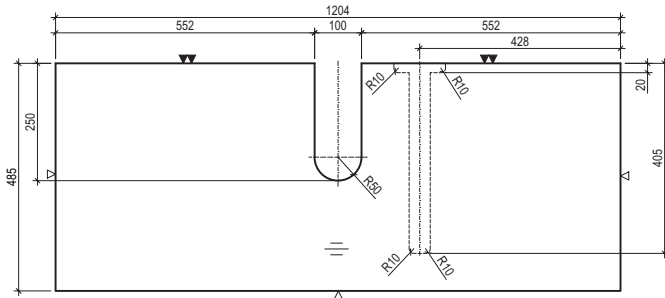

POCO/WTPP12R

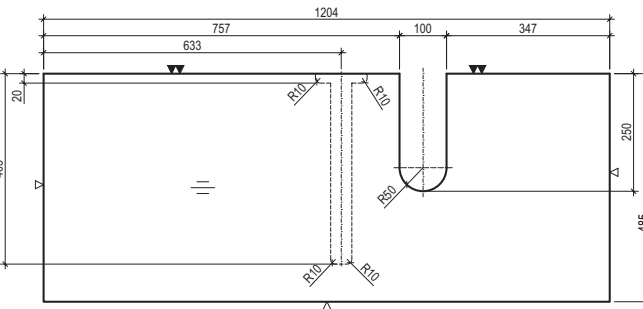

Achtung: Die Montage muss durch fachkundige Personen erfolgen. Der Untergrund zur Wandbefestigung ist vor Montage zu prüfen. Bitte wählen Sie entsprechend das geeignete Befestigungsmaterial. Fehlerhafte Montagen können das Möbel beschädigen oder dessen Funktion dauerhaft beeinträchtigen. Für Sach- und Personenschäden übernehmen wir im Falle einer unsachgemäßen Montage keine Haftung.

Attention: Assembly must be carried out by skilled personnel. The subsurface for the wall mounting must be checked before assembly. Please select a suitable mounting material. Faulty assembly can damage furniture or permanently impair its function. We will not be held responsible for damage to material or persons in the case of improper assembly.



Aufsatz-Waschbecken ohne Waschtischunterschrank

Bei allen Waschtischen die nur mit einer Platte an der Wand befestigt werden sollen, sind zwei Konsolen (WK) notwendig. Diese Konsolen werden unter die Waschtischplatte montiert und sind sichtbar. Bei der Montage von Waschtischunterschrank werden die Konsolen verdeckt.

Bitte bestellen Sie die Waschtischplatten mit der Artikelnummer WTP8, WTP10 oder WTP12.

On top washbasins without base cabinet

For all washbasins that are to be fixed to the wall with only one plate, two consoles (WCs) are required.

These consoles are mounted under the vanity top and are visible. When installing base cabinets, the consoles are hidden.

Please order the washbasin plates with article number WTP8, WTP10 or WTP12.



Aufsatz-Waschbecken „INGA“ (Mineralmarmor)

Artikel: MWING6

Der Waschtischbefestigung erfolgt mit einem MONK-4 (Montagebeschlag Waschbecken). Der MONK-4 (Montagebeschlag Waschbecken) ist im Lieferumfang des Waschtisches enthalten.

Die dazugehörigen Waschtischplatten (WTPI **) haben eine Ausfräsung auf der Unterseite um die Konsole aufzunehmen.

On top washbasin „INGA“ (mineral marble)

Article: MWING6

The washbasin mounting is to be done with a MONK-4 (mounting set washbasin). The MONK-4 (mounting set washbasin) is included.

*The matching washbasin plates (WTPI **) have a cutout on the underside to accommodate the console.*



Aufsatz-Waschbecken „BELLA“ (Keramik)

Artikel: KWBEL7

Die Waschtischbefestigung erfolgt mit einem MONK-4 (Montagebeschlag Waschbecken) oder mit Silikon auf der Waschtischplatte. Der MONK-4 (Montagebeschlag Waschbecken) ist im Lieferumfang des Waschtisches **nicht** enthalten.

Die dazugehörigen Waschtischplatten (WTPB**) haben eine Ausfräsung auf der Unterseite um die Konsole aufzunehmen.

On top washbasin „BELLA“ (ceramic)

Article: KWBEL7

*The washbasin mounting is to be done with a MONK-4 (mounting set washbasin) or by fixing with silicone on the plate. The MONK-4 (mounting set washbasin) is **not** included.*

*The associated washbasin plates (WTPB **) have a cutout on the underside to accommodate the console.*



Aufsatz-Waschbecken „POCO“ (Keramik)

Artikel: KWPOC55

Die Waschtischbefestigung erfolgt mit einem MONK-4 (Montagebeschlag Waschbecken) oder mit Silikon auf der Waschtischplatte. Der MONK-4 (Montagebeschlag Waschbecken) ist im Lieferumfang des Waschtisches enthalten.

Die dazugehörigen Waschtischplatten (WTPP **) haben eine Ausfräsung auf der Unterseite um die Konsole aufzunehmen.

On top washbasin „POCO“ (ceramic)

Article: KWPOC55

The washbasin mounting is to be done with a MONK-4 (mounting set washbasin) or by fixing with silicone on the plate. The MONK-4 (mounting set washbasin) is included.

*The associated washbasin plates (WTPP **) have a cutout on the underside to accommodate the console.*

! Achtung: Die Montage muss durch fachkundige Personen erfolgen. Der Untergrund zur Wandbefestigung ist vor Montage zu prüfen. Bitte wählen Sie entsprechend das geeignete Befestigungsmaterial. Fehlerhafte Montagen können das Möbel beschädigen oder dessen Funktion dauerhaft beeinträchtigen. Für Sach- und Personenschäden übernehmen wir im Falle einer unsachgemäßen Montage keine Haftung.
 Attention: Assembly must be carried out by skilled personnel. The subsurface for the wall mounting must be checked before assembly. Please select a suitable mounting material. Faulty assembly can damage furniture or permanently impair its function. We will not be held responsible for damage to material or persons in the case of improper assembly.

3390 »Maße/dimensions«

Bohrlochhöhen für Schraubhaken, Anschlussmaße und Abflusshöhen/drilling point for screw hooks, dimensions for mounting and drain

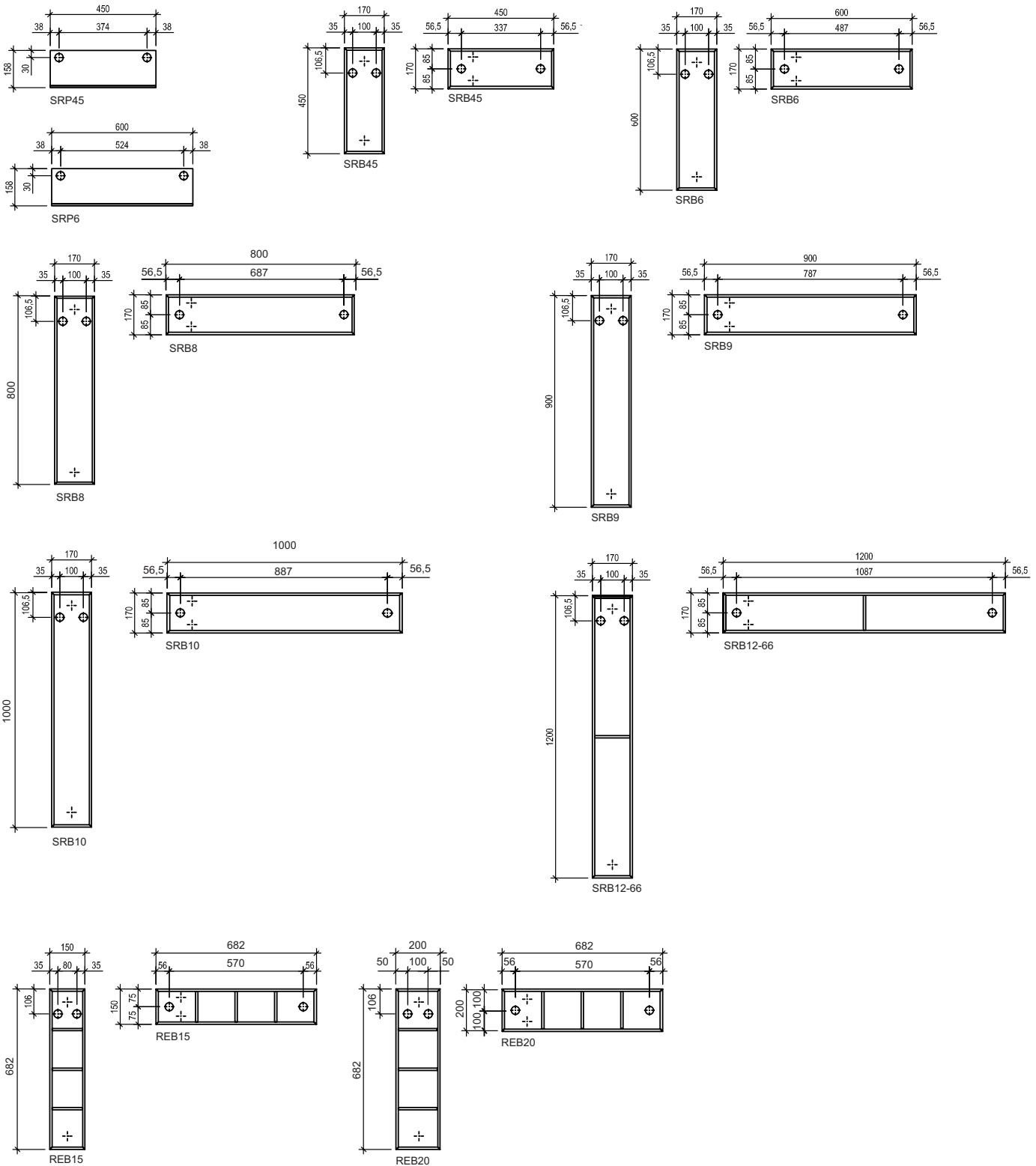

Achtung: Die Montage muss durch fachkundige Personen erfolgen. Der Untergrund zur Wandbefestigung ist vor Montage zu prüfen. Bitte wählen Sie entsprechend das geeignete Befestigungsmaterial. Fehlerhafte Montagen können das Möbel beschädigen oder dessen Funktion dauerhaft beeinträchtigen. Für Sach- und Personenschäden übernehmen wir im Falle einer unsachgemäßen Montage keine Haftung.

Attention: Assembly must be carried out by skilled personnel. The subsurface for the wall mounting must be checked before assembly. Please select a suitable mounting material. Faulty assembly can damage furniture or permanently impair its function. We will not be held responsible for damage to material or persons in the case of improper assembly.