

Möbel LETZ

Finden und Wohlfühlen



Typenplan

CL 970 von Erpo Polstermöbel - Sofa-Duo senf

Wichtiger Hinweis für Sie

Etwaige Hinweise des Herstellers in dieser Produktinformation, die sich auf die Gewährleistung beziehen, haben für Sie keinerlei Bindungswirkung und können von Ihnen ignoriert werden. Ihre gesetzlichen Gewährleistungsrechte als Verbraucher uns gegenüber, als Ihrem Verkäufer, werden dadurch in keiner Weise berührt oder eingeschränkt. Sie können sich wegen aller Mängel jederzeit an uns wenden. Darüber hinaus gehende Herstellergarantien bleiben natürlich unberührt. Dieser Artikel wird hergestellt von Erpo Möbelwerk GmbH, Albert-Einstein-Straße 9, 88521 Ertingen, Deutschland

Möbel Letz GmbH
Am Gewerbepark 11
06895 Zahna-Elster

Tel.: 035383 - 6018 50

Fax.: 035383 - 6018 17

CLASSICS

erpo[®]
Sitz. Kultur.

CL 970



CL 970

CLASSICS

Produktinformation

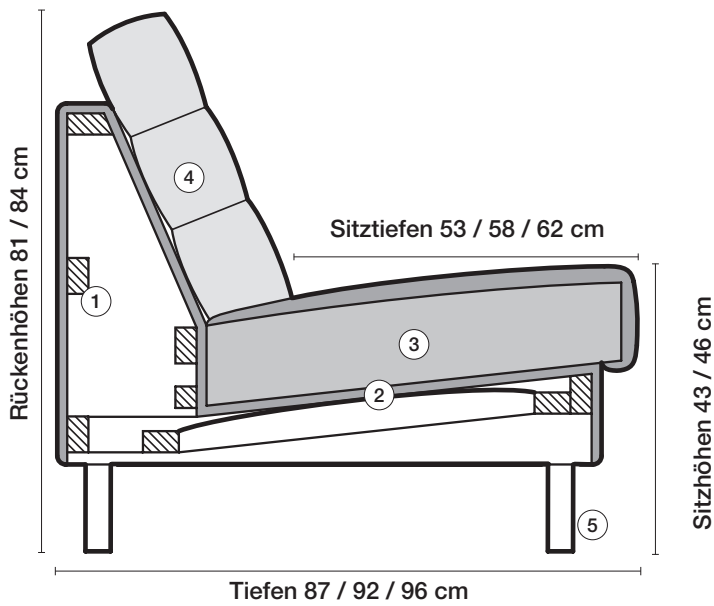

① **Gestell**
Hartholzgestell aus Buche, gedübelt und verleimt.

② **Unterfederung**
Stahlwellenunterfederung mit Spezialabdeckung aus hochwertigem Futterstoff.

③ **Sitzkissen**
Daunencharakter
Comfort SL
Kaltschaumkombination
Taschenfederkern
Comfort Plus

④ **Rückenkissen**
Daunencharakter
Comfort SL
Kaltschaumkombination

Sitztiefen
Sitztiefe 53 cm
Sitztiefe 58 cm
Sitztiefe 62 cm

Sitzhöhen
Sitzhöhe 43 cm
Sitzhöhe 46 cm
Sonderhöhen möglich

⑤ **Fussausführungen**

Gestell Hartholzgestell aus Buche, gedübelt und verleimt.

Unterfederung Stahlwellenunterfederung mit Spezialabdeckung und hochwertigem Futterstoff.

Sitzkissen A Daunencharakter
Legere Ausführung in bewährter Kammerkissenverarbeitung und stabilisierendem Sitzkern aus Polyetherschaum RG 43. Füllung Polyschaumstäbchen mit hochwertigen Vliesfasern.

B Comfort SL
Weiche besonders anpassungsfähige Ausführung mit stabilisierendem Sitzkern aus Polyetherschaum RG 42. Füllung Polyschaumstäbchen in bewährter Kammerkissenverarbeitung.

C Kaltschaumkombination
Festere Ausführung aus hochwertiger Kaltschaumkombination. Formstabil durch festen Polyetherkern RG 43 und angenehm weicher Kaltschaumabdeckung RG 35.

D Taschenfederkern mit Daunencharakter
Klassischer Sitzkomfort durch einzeln in Taschen eingenähte zylindrische Federkerne, die mit hochwertigem Kaltschaum RG 40 ummantelt sind. Legere Oberfläche durch bewährte Kammerkissenverarbeitung. Füllung Polyschaumstäbchen RG 40. **Aufpreis siehe Sonderanfertigungen.**

G Comfort Plus
legere Ausführung in bewährter Stegmattenverarbeitung mit stabilisierendem Kern aus Kaltschaum RG 50. Füllung Polyschaumstäbchen mit hochwertigen Vliesfasern. **Aufpreis siehe Sonderanfertigungen.**

Sitztiefen
Sitztiefe 53 cm
Sitztiefe 58 cm (Mehrpreis 8 %)
Sitztiefe 62 cm (Mehrpreis 10 %)

Sitzhöhen
Sitzhöhe 43 cm
Sitzhöhe 46 cm
Durch Verlängerung des Seitenteils ohne Aufpreis.

Bitte Sitztiefe und Sitzhöhe bei der Bestellung unbedingt angeben.

Rückenkissen A Daunencharakter
Legere Ausführung in bewährter Kammerkissenverarbeitung. Füllung aus Polyschaumstäbchen und hochwertigen Vliesfasern.

B Comfort SL
Weiche besonders anpassungsfähige Ausführung in bewährter Kammerkissen-Verarbeitung. Füllung aus hochwertigen Vliesfaserkugeln.

C Kaltschaum
Formstabiler Kern aus hochwertigem Kaltschaum RG 50. Abdeckung aus Polyetherschaum RG 20 mit Vlieskaschierung.

Produktumfang

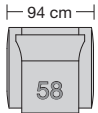

970.12

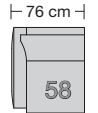

970.40 L/R

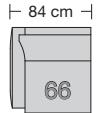

970.41 L/R

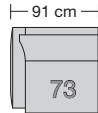

970.42 L/R

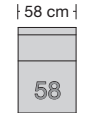

970.50

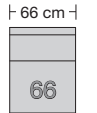

970.51

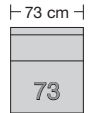

970.52

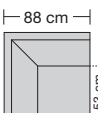

970.70 R

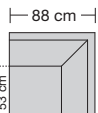

970.70 L

ST 58 = 93 x 93 cm

ST 62 cm = 97 x 97 cm

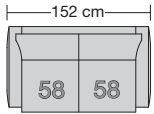

970.22

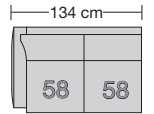

970.44 L/R

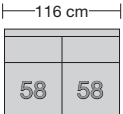

970.54

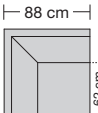

970.76 R

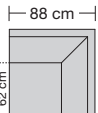

970.76 L

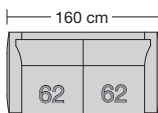

970.23

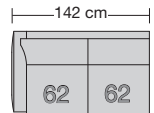

970.45 L/R

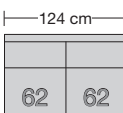

970.55

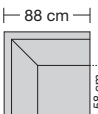

970.761 R

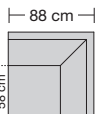

970.761 L

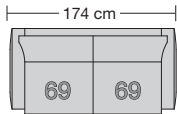

970.24

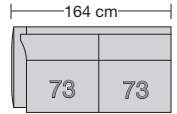

970.46 L/R

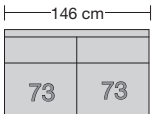

970.56

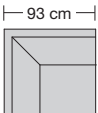

970.762 R

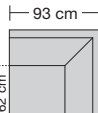

970.762 L

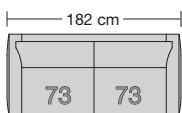

970.25

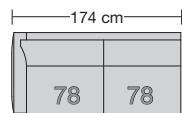

970.47 L/R

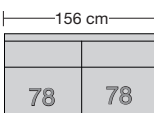

970.57

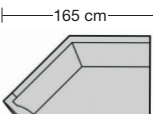

970.74 L

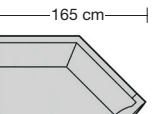

970.74 R

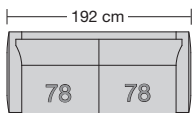

970.26

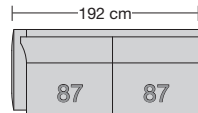

970.48 L/R

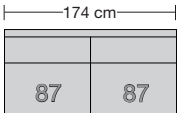

970.58

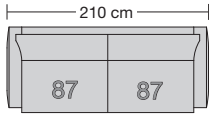

970.27

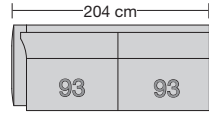

970.49 L/R

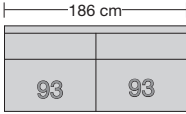

970.59

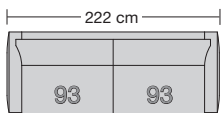

970.28

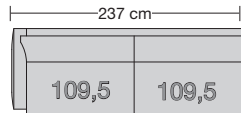

970.495 L/R

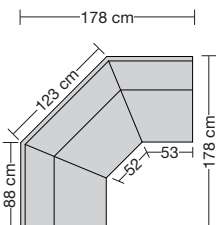

970.75 Seitenmaß 251 x 128 cm

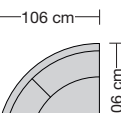

970.73

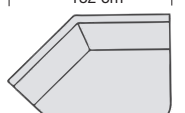

970.71

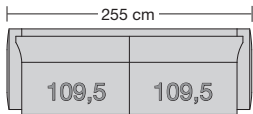

970.29

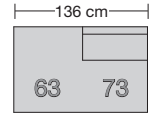

970.67 L/R

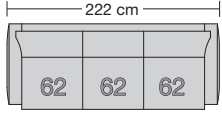

970.32

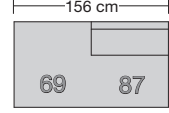

970.69 L/R

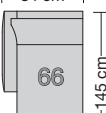

970.78 L/R

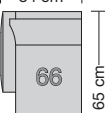

970.79 L/R

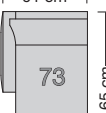

970.792 L/R

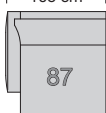

970.795 L/R



970.798 L/R

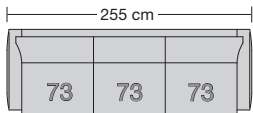

970.35

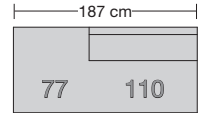

970.695 L/R

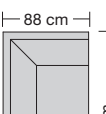

970.752 L/R

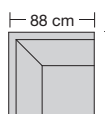

970.755 L/R

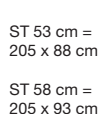

970.772 L/R

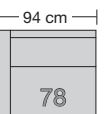

970.775 L/R

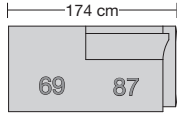

970.250 L/R

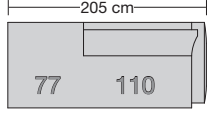

970.270 L/R

Die Zahlen, welche in den Elementen angegeben werden, repräsentieren die ca. Sitzkissenbreite in Zentimeter. Sitztiefe, Sitzhöhe, Armlehne und KissenAusführung bitte bei der Bestellung unbedingt angeben.

Füsse



Fuss Aluminiumguss oval, 37 x 25 mm,
CL7: 125 mm hoch für **Sitzhöhe 43 cm**
CL75: 155 mm hoch für **Sitzhöhe 46 cm**
hochglanz poliert, matt poliert oder schwarz matt pulverbeschichtet

CL 7/75



Holzfuß mit Metallteller in Chrom hochglanz oder schwarz matt pulverbeschichtet. Ø 50 mm in allen Erpo Basisfarben. Sonderfarben gegen Aufpreis.
CL12: 130 mm hoch für **Sitzhöhe 43 cm**
CL125: 160 mm hoch für **Sitzhöhe 46 cm**
CL126: 180 mm hoch für **Sitzhöhe 48 cm**

CL 12 / 125 / 126

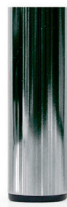

Metallfuß rund, Ø 40 mm **hochglanz verchromt** oder **matt verchromt**
CL30: 130 mm hoch für **Sitzhöhe 43 cm**
CL305: 160 mm hoch für **Sitzhöhe 46 cm**

CL 30 / 305



Holzfuß Buche rund, Ø 60 mm Buche natur, Eiche natur oder in allen Erpo Basisfarben. Sonderfarben gegen Aufpreis.
CL40: 130 mm hoch für **Sitzhöhe 43 cm**
CL405: 160 mm hoch für **Sitzhöhe 46 cm**
CL406: 180 mm hoch für **Sitzhöhe 48 cm**

CL 40 / 405 / 406



Holzfuß Buche, 90 x 90 mm, in allen Erpo Basisfarben. Sonderfarben gegen Aufpreis oder in **Eiche natur**.
CL48: 130 mm hoch für **Sitzhöhe 43 cm**
CL485: 160 mm hoch für **Sitzhöhe 46 cm**

CL 48 / 485



Metallfuß rund, Ø 60 mm **hochglanz verchromt, matt verchromt** oder **schwarz matt pulverbeschichtet**.
CL50: 130 mm hoch für **Sitzhöhe 43 cm**
CL505: 160 mm hoch für **Sitzhöhe 46 cm**
CL506: 180 mm hoch für **Sitzhöhe 48 cm**

CL 50 / 505 / 506



Metallfuß diagonal angeordnet, 30-44 mm **hochglanz verchromt, matt verchromt** oder **schwarz matt pulverbeschichtet**.
CL57: 130 mm hoch für **Sitzhöhe 43 cm**
CL575: 160 mm hoch für **Sitzhöhe 46 cm**

CL 57 / 575



Fuss Aluminiumguss oval, **hochglanz poliert** oder **schwarz matt pulverbeschichtet** Ø 16-29 mm
CL59: 130 mm hoch für **Sitzhöhe 43 cm**
CL595: 160 mm hoch für **Sitzhöhe 46 cm**
 Bei Parkett kann dieser Fuss zu Abdrücken führen.

CL 59 / 595



Aluminium natur, Ø 40 mm
CL60: 130 mm hoch für **Sitzhöhe 43 cm**
CL605: 160 mm hoch für **Sitzhöhe 46 cm**

CL 60 / 605



Metallfuß rund, höhenverstellbar von 130 - 155 mm, für **Sitzhöhe 43 - 45 cm**, Ø 30 mm, **hochglanz verchromt, titanfarbig** oder **schwarz matt pulverbeschichtet**.
 Sonderlackierung in allen RAL Farben gegen Aufpreis.

CL 80



Kufe Buche, 50 x 30 mm, 130, 160 oder 180 mm hoch. In allen Erpo Basisfarben. Sonderfarben gegen Aufpreis oder in Eiche natur für **Sitzhöhe 43, 46 oder 48 cm**

Aufpreis pro Kufe
 in Buche
 in Eiche

Kufe 2



Metall quadratisch, 30 x 30 mm, 130 oder 150 mm hoch, für **Sitzhöhe 43 oder 45 cm**, **hochglanz verchromt** oder **matt verchromt**.

Aufpreis pro Kufe

Kufe 3



Metall Flachstahl, 50 mm breit, 130 oder 150 mm hoch, für **Sitzhöhe 43 oder 45 cm**, **hochglanz verchromt, matt verchromt** oder **schwarz matt pulverbeschichtet**.
 Kufe immer mittig unter Armlehne montiert.

Aufpreis pro Kufe
 in chrom
 in schwarz





Kufe 5



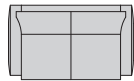

Metall Flachstahl, 80 mm breit, 130 oder 150 mm hoch, für **Sitzhöhe 43 oder 45 cm**, **hochglanz verchromt, matt verchromt** oder **schwarz matt pulverbeschichtet**.
 Kufe immer mittig unter Armlehne montiert.

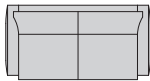
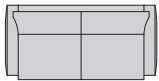
Aufpreis pro Kufe
 in chrom
 in schwarz

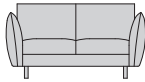
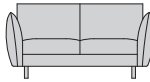
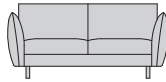
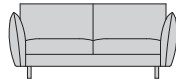



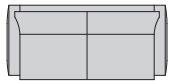

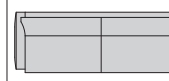
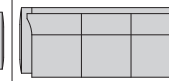
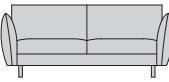
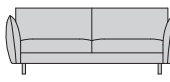
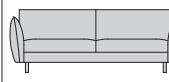
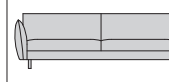
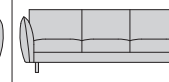
Kufe 8

Sitztiefe, Sitzhöhe, Armlehne und Kissenführung bitte bei der Bestellung unbedingt angeben.					
					
	Sessel	Sofa 2-sitzig	Sofa 2-sitzig	Sofa 2-sitzig	Sofa 2 1/2-sitzig
Breite	94 cm	152 cm	160 cm	174 cm	182 cm
Bestell-Nr.	970.12	970.22	970.23	970.24	970.25
Sitztiefe 53 cm					
Sitztiefe 58 cm / 8 % Aufpreis					
Sitztiefe 62 cm / 10 % Aufpreis					
Stoffgruppe	13				
	14				
	15				
	16				
	17				
	18				
	19				
	20				
Ledergruppe					
	Ledergruppe D				
(Leder 170)	Ledergruppe E				
	Ledergruppe F				
(Leder 190)	Ledergruppe G				
	Ledergruppe H				
(Leder 43)	Ledergruppe I				
(Leder 42)	Ledergruppe J				
(Leder 250)	Ledergruppe K				
(Leder 430/45)	Ledergruppe L				
(Leder 390)	Ledergruppe M				
(Leder 450)	Ledergruppe N				
(Leder 550)	Ledergruppe O				
	Ledergruppe P				
	Ledergruppe Q				
Mehrpriis Armlehnverstellung					
Stoffbedarf, ohne Rapport					
140 cm breit	4.70 m	6.60 m	6.90 m	7.30 m	7.50 m

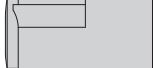
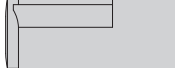

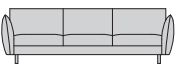



CL 970

Sitztiefe, Sitzhöhe, Armlehne und Kissenführung bitte bei der Bestellung unbedingt angeben.					
					
	Sofa 2 1/2-sitzig	Sofa 2 1/2-sitzig	Sofa 2 1/2-sitzig	Sofa 2 1/2-sitzig	Sofa 3-sitzig
Breite	192 cm	210 cm	222 cm	255 cm	222 cm
Bestell-Nr.	970.26	970.27	970.28	970.29	970.32
Sitztiefe 53 cm					
Sitztiefe 58 cm / 8 % Aufpreis					
Sitztiefe 62 cm / 10 % Aufpreis					
Stoffgruppe	13				
	14				
	15				
	16				
	17				
	18				
	19				
	20				
Ledergruppe					
	Ledergruppe D				
(Leder 170)	Ledergruppe E				
	Ledergruppe F				
(Leder 190)	Ledergruppe G				
	Ledergruppe H				
(Leder 43)	Ledergruppe I				
(Leder 42)	Ledergruppe J				
(Leder 250)	Ledergruppe K				
(Leder 430/45)	Ledergruppe L				
(Leder 390)	Ledergruppe M				
(Leder 450)	Ledergruppe N				
(Leder 550)	Ledergruppe O				
	Ledergruppe P				
	Ledergruppe Q				
Mehrpreis Armlehnverstellung					
Stoffbedarf, ohne Rapport					
140 cm breit	7.70 m	8.20 m	8.60 m	9.50 m	9.00 m

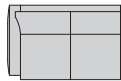

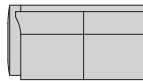
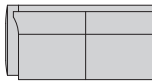
CL 970

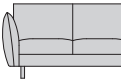
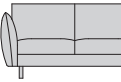
Sitztiefe, Sitzhöhe, Armlehne und Kissenausführung bitte bei der Bestellung unbedingt angeben.					
					
	Sofa 3-sitzig	Sofa mit offenem Abschluss	Sofa mit offenem Abschluss	Anreihenelement	Anreihenelement
Breite	255 cm	174 cm	205 cm	76 cm	84 cm
Bestell-Nr.	970.35	970.250 L/R	970.270 L/R	970.40 L/R	970.41 L/R
Sitztiefe 53 cm					
Sitztiefe 58 cm / 8 % Aufpreis					
Sitztiefe 62 cm / 10 % Aufpreis					
Stoffgruppe	13				
	14				
	15				
	16				
	17				
	18				
	19				
	20				
Ledergruppe					
	Ledergruppe D				
(Leder 170)	Ledergruppe E				
	Ledergruppe F				
(Leder 190)	Ledergruppe G				
	Ledergruppe H				
(Leder 43)	Ledergruppe I				
(Leder 42)	Ledergruppe J				
(Leder 250)	Ledergruppe K				
(Leder 430/45)	Ledergruppe L				
(Leder 390)	Ledergruppe M				
(Leder 450)	Ledergruppe N				
(Leder 550)	Ledergruppe O				
	Ledergruppe P				
	Ledergruppe Q				
Mehrpriis Armlehnverstellung					
Stoffbedarf, ohne Rapport					
140 cm breit	9.80 m	5.80 m	6.50 m	3.80 m	4.10 m



CL 970

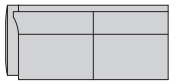
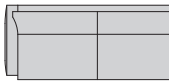
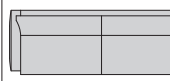
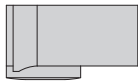

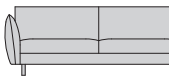
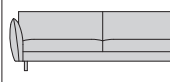
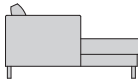
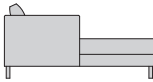



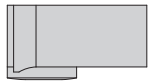
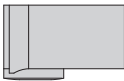
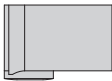
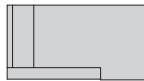
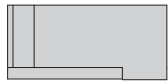
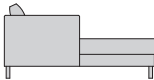
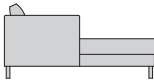
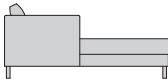
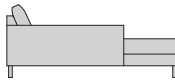

Sitztiefe, Sitzhöhe, Armlehne und Kissenführung bitte bei der Bestellung unbedingt angeben.					
					
Breite	91 cm	134 cm	142 cm	164 cm	174 cm
Bestell-Nr.	970.42 L/R	970.44 L/R	970.45 L/R	970.46 L/R	970.47 L/R
Sitztiefe 53 cm					
Sitztiefe 58 cm / 8 % Aufpreis					
Sitztiefe 62 cm / 10 % Aufpreis					
Stoffgruppe	13				
	14				
	15				
	16				
	17				
	18				
	19				
	20				
Ledergruppe					
	Ledergruppe D				
(Leder 170)	Ledergruppe E				
	Ledergruppe F				
(Leder 190)	Ledergruppe G				
	Ledergruppe H				
(Leder 43)	Ledergruppe I				
(Leder 42)	Ledergruppe J				
(Leder 250)	Ledergruppe K				
(Leder 430/45)	Ledergruppe L				
(Leder 390)	Ledergruppe M				
(Leder 450)	Ledergruppe N				
(Leder 550)	Ledergruppe O				
	Ledergruppe P				
	Ledergruppe Q				
Mehrpreis Armlehnverstellung					
Stoffbedarf, ohne Rapport					
140 cm breit	4.40 m	5.60 m	5.80 m	6.30 m	6.60 m

CL 970



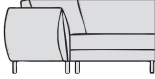







Sitztiefe, Sitzhöhe, Armlehne und Kissenausführung bitte bei der Bestellung unbedingt angeben.					
					
Breite	Anreihsofa 2 1/2-sitzig 192 cm	Anreihsofa 2 1/2-sitzig 204 cm	Anreihsofa 2 1/2-sitzig 237 cm	Longchair 84 x 145 cm	Longchair 84 x 165 cm
Bestell-Nr.	970.48 L/R	970.49 L/R	970.495 L/R	970.78 L/R	970.79 L/R
Sitztiefe 53 cm					
Sitztiefe 58 cm / 8 % Aufpreis					
Sitztiefe 62 cm / 10 % Aufpreis					
Stoffgruppe	13				
	14				
	15				
	16				
	17				
	18				
	19				
	20				
Ledergruppe					
	Ledergruppe D				
(Leder 170)	Ledergruppe E				
	Ledergruppe F				
(Leder 190)	Ledergruppe G				
	Ledergruppe H				
(Leder 43)	Ledergruppe I				
(Leder 42)	Ledergruppe J				
(Leder 250)	Ledergruppe K				
(Leder 430/45)	Ledergruppe L				
(Leder 390)	Ledergruppe M				
(Leder 450)	Ledergruppe N				
(Leder 550)	Ledergruppe O				
	Ledergruppe P				
	Ledergruppe Q				
Mehrpriis Armlehnverstellung					
Stoffbedarf, ohne Rapport					
140 cm breit	7.10 m	7.40 m	7.80 m	4.90 m	5.00 m







CL 970

Sitztiefe, Sitzhöhe, Armlehne und Kissenführung bitte bei der Bestellung unbedingt angeben.					
					
	Longchair	Longchair	Longchair	Ecksofa Rückenarmlehne 16 cm	Ecksofa Rückenarmlehne 16 cm
Breite	91 x 165 cm	105 x 165 cm	128 x 180 cm	94 x 192 cm	94 x 222 cm
Bestell-Nr.	970.792 L/R	970.795 L/R	970.798 L/R	970.772 L/R	970.775 L/R
Sitztiefe 53 cm					
Sitztiefe 58 cm / 8 % Aufpreis					
Sitztiefe 62 cm / 10 % Aufpreis					
Stoffgruppe	13				
	14				
	15				
	16				
	17				
	18				
	19				
	20				
Ledergruppe					
	Ledergruppe D				
(Leder 170)	Ledergruppe E				
	Ledergruppe F				
(Leder 190)	Ledergruppe G				
	Ledergruppe H				
(Leder 43)	Ledergruppe I				
(Leder 42)	Ledergruppe J				
(Leder 250)	Ledergruppe K				
(Leder 430/45)	Ledergruppe L				
(Leder 390)	Ledergruppe M				
(Leder 450)	Ledergruppe N				
(Leder 550)	Ledergruppe O				
	Ledergruppe P				
	Ledergruppe Q				
Mehrpreis Armlehnverstellung					
Stoffbedarf, ohne Rapport					
140 cm breit	5.40 m	6.10 m	6.30 m	6.10 m	6.80 m

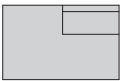



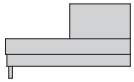
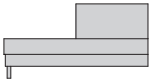
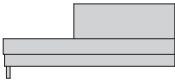





Sitztiefe, Sitzhöhe, Armlehne und Kissenführung bitte bei der Bestellung unbedingt angeben.					
					
	Loungeelement	Anbauelement	Anbauelement	Anbauelement	Anbausofa 2-sitzig
Breite	165 x 132 cm	58 cm	66 cm	73 cm	116 cm
Bestell-Nr.	970.74 L/R	970.50	970.51	970.52	970.54
Sitztiefe 53 cm					
Sitztiefe 58 cm / 8 % Aufpreis					
Sitztiefe 62 cm / 10 % Aufpreis					
Stoffgruppe	13				
	14				
	15				
	16				
	17				
	18				
	19				
	20				
Ledergruppe					
	Ledergruppe D				
(Leder 170)	Ledergruppe E				
	Ledergruppe F				
(Leder 190)	Ledergruppe G				
	Ledergruppe H				
(Leder 43)	Ledergruppe I				
(Leder 42)	Ledergruppe J				
(Leder 250)	Ledergruppe K				
(Leder 430/45)	Ledergruppe L				
(Leder 390)	Ledergruppe M				
(Leder 450)	Ledergruppe N				
(Leder 550)	Ledergruppe O				
	Ledergruppe P				
	Ledergruppe Q				
Stoffbedarf, ohne Rapport					
140 cm breit	6.80 m	2.70 m	3.00 m	3.30 m	4.10 m







CL 970

Sitztiefe, Sitzhöhe, Armlehne und Kissenführung bitte bei der Bestellung unbedingt angeben.					
					
	Anbausofa 2-sitzig	Anbausofa 2 1/2-sitzig	Anbausofa 2 1/2-sitzig	Anbausofa 2 1/2-sitzig	Anbausofa 2 1/2-sitzig
Breite	124 cm	146 cm	156 cm	174 cm	186 cm
Bestell-Nr.	970.55	970.56	970.57	970.58	970.59
Sitztiefe 53 cm					
Sitztiefe 58 cm / 8 % Aufpreis					
Sitztiefe 62 cm / 10 % Aufpreis					
Stoffgruppe	13				
	14				
	15				
	16				
	17				
	18				
	19				
	20				
Ledergruppe					
	Ledergruppe D				
(Leder 170)	Ledergruppe E				
	Ledergruppe F				
(Leder 190)	Ledergruppe G				
	Ledergruppe H				
(Leder 43)	Ledergruppe I				
(Leder 42)	Ledergruppe J				
(Leder 250)	Ledergruppe K				
(Leder 430/45)	Ledergruppe L				
(Leder 390)	Ledergruppe M				
(Leder 450)	Ledergruppe N				
(Leder 550)	Ledergruppe O				
	Ledergruppe P				
	Ledergruppe Q				
Stoffbedarf, ohne Rapport					
140 cm breit	4.60 m	5.30 m	5.80 m	6.10 m	6.20 m

Sitztiefe, Sitzhöhe, Armlehne und Kissenführung bitte bei der Bestellung unbedingt angeben.					
					
	Abschlusselement mit Hocker	Abschlusselement mit Hocker	Abschlusselement mit Hocker	Eckelement ST 53 / 53	Eckelement ST 58 / 58
Breite	136 cm	156 cm	187 cm	88 x 88 cm	93 x 93 cm
Bestell-Nr.	970.67 L/R	970.69 L/R	970.695 L/R	970.70	970.70
Sitztiefe 53 cm					
Sitztiefe 58 cm / 8 % Aufpreis					
Sitztiefe 62 cm / 10 % Aufpreis					
Stoffgruppe	13				
	14				
	15				
	16				
	17				
	18				
	19				
	20				
Ledergruppe					
	Ledergruppe D				
(Leder 170)	Ledergruppe E				
	Ledergruppe F				
(Leder 190)	Ledergruppe G				
	Ledergruppe H				
(Leder 43)	Ledergruppe I				
(Leder 42)	Ledergruppe J				
(Leder 250)	Ledergruppe K				
(Leder 430/45)	Ledergruppe L				
(Leder 390)	Ledergruppe M				
(Leder 450)	Ledergruppe N				
(Leder 550)	Ledergruppe O				
	Ledergruppe P				
	Ledergruppe Q				
Stoffbedarf, ohne Rapport					
140 cm breit	5.30 m	5.80 m	5.90 m	4.90 m	5.00 m

CL 970

Sitztiefe, Sitzhöhe, Armlehne und Kissenführung bitte bei der Bestellung unbedingt angeben.					
					
	Eckelement ST 62 / 62	Eckelement ST 53 / 58	Eckelement ST 58 / 53	Eckelement ST 53 / 62	Eckelement ST 62 / 53
Breite	97 x 97 cm	88 x 93 cm	88 x 93 cm	88 x 97 cm	88 x 97 cm
Bestell-Nr.	970.70	970.761 L	970.761 R	970.76 L	970.76 R
Sitztiefe 53 cm					
Sitztiefe 58 cm / 8 % Aufpreis					
Sitztiefe 62 cm / 10 % Aufpreis					
Stoffgruppe	13				
	14				
	15				
	16				
	17				
	18				
	19				
	20				
Ledergruppe					
	Ledergruppe D				
(Leder 170)	Ledergruppe E				
	Ledergruppe F				
(Leder 190)	Ledergruppe G				
	Ledergruppe H				
(Leder 43)	Ledergruppe I				
(Leder 42)	Ledergruppe J				
(Leder 250)	Ledergruppe K				
(Leder 430/45)	Ledergruppe L				
(Leder 390)	Ledergruppe M				
(Leder 450)	Ledergruppe N				
(Leder 550)	Ledergruppe O				
	Ledergruppe P				
	Ledergruppe Q				
Stoffbedarf, ohne Rapport					
140 cm breit	5.00 m	5.00 m	5.00 m	5.00 m	5.00 m

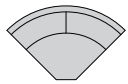
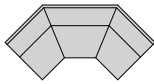
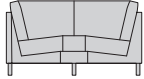
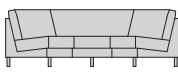

<p>Sitztiefe, Sitzhöhe, Armlehne und Kissenführung bitte bei der Bestellung unbedingt angeben.</p>	 	 	 		
<p>Breite</p>	<p>Eckelement ST 58 / 62 93 x 97 cm</p>	<p>Eckelement ST 62 / 58 93 x 97 cm</p>	<p>Loungeeckelement 152 x 136 cm</p>		
<p>Bestell-Nr.</p>	<p>970.762 L</p>	<p>970.762 R</p>	<p>970.71</p>		
<p>Sitztiefe 53 cm</p>					
<p>Sitztiefe 58 cm / 8 % Aufpreis</p>					
<p>Sitztiefe 62 cm / 10 % Aufpreis</p>					
<p>Stoffgruppe</p>	<p>13</p>				
<p></p>	<p>14</p>				
<p></p>	<p>15</p>				
<p></p>	<p>16</p>				
<p></p>	<p>17</p>				
<p></p>	<p>18</p>				
<p></p>	<p>19</p>				
<p></p>	<p>20</p>				
<p>Ledergruppe</p>					
<p></p>	<p>Ledergruppe D</p>				
<p>(Leder 170)</p>	<p>Ledergruppe E</p>				
<p></p>	<p>Ledergruppe F</p>				
<p>(Leder 190)</p>	<p>Ledergruppe G</p>				
<p></p>	<p>Ledergruppe H</p>				
<p>(Leder 43)</p>	<p>Ledergruppe I</p>				
<p>(Leder 42)</p>	<p>Ledergruppe J</p>				
<p>(Leder 250)</p>	<p>Ledergruppe K</p>				
<p>(Leder 430/45)</p>	<p>Ledergruppe L</p>				
<p>(Leder 390)</p>	<p>Ledergruppe M</p>				
<p>(Leder 450)</p>	<p>Ledergruppe N</p>				
<p>(Leder 550)</p>	<p>Ledergruppe O</p>				
<p></p>	<p>Ledergruppe P</p>				
<p></p>	<p>Ledergruppe Q</p>				
<p></p>					
<p></p>					
<p></p>					
<p></p>					
<p></p>					
<p></p>					
<p></p>					
<p></p>					
<p></p>					
<p></p>					
<p></p>					
<p></p>					
<p>Stoffbedarf, ohne Rapport</p>					
<p>140 cm breit</p>	<p>5.00 m</p>	<p>5.00 m</p>	<p>5.60 m</p>		

CL 970

Sitztiefe, Sitzhöhe, Armlehne und Kissenführung bitte bei der Bestellung unbedingt angeben.					
					
Breite	Rundeckelement 90° 106 x 106 cm	Trapezeckelement 178 x 178 cm			
Bestell-Nr.	970.73	970.75			
Sitztiefe 53 cm					
Sitztiefe 58 cm / 8 % Aufpreis					
Sitztiefe 62 cm / 10 % Aufpreis					
Stoffgruppe	13				
	14				
	15				
	16				
	17				
	18				
	19				
	20				
Ledergruppe					
	Ledergruppe D				
(Leder 170)	Ledergruppe E				
	Ledergruppe F				
(Leder 190)	Ledergruppe G				
	Ledergruppe H				
(Leder 43)	Ledergruppe I				
(Leder 42)	Ledergruppe J				
(Leder 250)	Ledergruppe K				
(Leder 430/45)	Ledergruppe L				
(Leder 390)	Ledergruppe M				
(Leder 450)	Ledergruppe N				
(Leder 550)	Ledergruppe O				
	Ledergruppe P				
	Ledergruppe Q				
Stoffbedarf, ohne Rapport					
140 cm breit	4.70 m	8.00 m			

CL 970

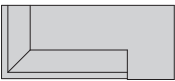
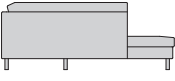
Eckabschlusselement

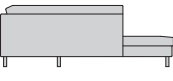
<p>Bitte beachten Sie, dass das Eckabschlusselement nur in der Sitztiefe des angebauten Elementes geliefert werden kann!</p>	 	 			
<p>Breite</p>	<p>Eckabschluss- element 205 cm</p>	<p>Eckabschluss- element 225 cm</p>			
<p>Bestell-Nr.</p>	<p>970.752 L/R</p>	<p>970.755 L/R</p>			
<p>Sitztiefe 53 cm</p>					
<p>Sitztiefe 58 cm / 8 % Aufpreis</p>	<p>Bitte beachten Sie die Informationen oben links.</p>				
<p>Sitztiefe 62 cm / 10 % Aufpreis</p>					
<p>Stoffgruppe</p>	<p>13 14 15 16 17 18 19 20</p>				
<p>Ledergruppe</p>	<p>Ledergruppe D (Leder 170) Ledergruppe E Ledergruppe F (Leder 190) Ledergruppe G Ledergruppe H (Leder 43) Ledergruppe I (Leder 42) Ledergruppe J (Leder 250) Ledergruppe K (Leder 430/45) Ledergruppe L (Leder 390) Ledergruppe M (Leder 450) Ledergruppe N (Leder 550) Ledergruppe O Ledergruppe P Ledergruppe Q</p>				
<p>Stoffbedarf, ohne Rapport</p>					
<p>140 cm breit</p>	<p>7.30 m</p>	<p>7.70 m</p>			