

Möbel LETZ

Finden und Wohlfühlen



Typenplan

CL 650 von Erpo Polstermöbel - Eckgarnitur rechts grau

Wichtiger Hinweis für Sie

Etwaige Hinweise des Herstellers in dieser Produktinformation, die sich auf die Gewährleistung beziehen, haben für Sie keinerlei Bindungswirkung und können von Ihnen ignoriert werden. Ihre gesetzlichen Gewährleistungsrechte als Verbraucher uns gegenüber, als Ihrem Verkäufer, werden dadurch in keiner Weise berührt oder eingeschränkt. Sie können sich wegen aller Mängel jederzeit an uns wenden. Darüber hinaus gehende Herstellergarantien bleiben

Ertingen, Deutschland

Möbel Letz GmbH
Am Gewerbepark 11
06895 Zahna-Elster

Tel.: 035383 - 6018 50

Fax.: 035383 - 6018 17

CLASSICS

erpo[®]
Sitz. Kultur.

CL 650



CL 650

CLASSICS

Produktinformation

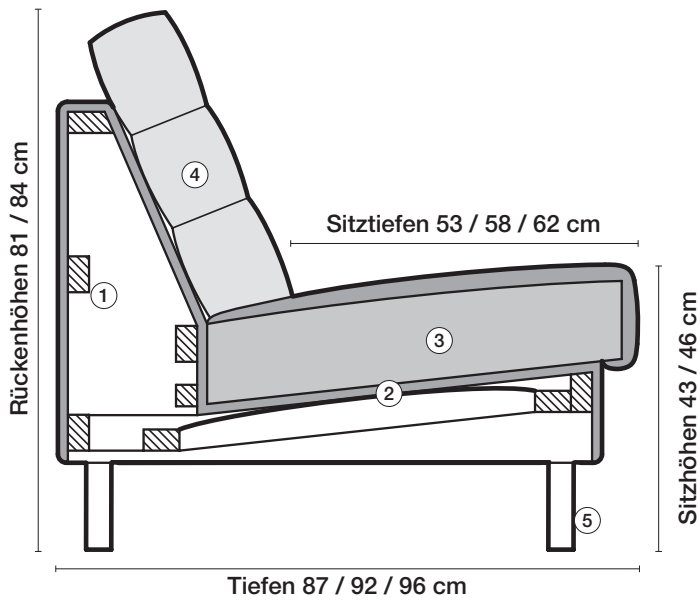

① **Gestell**
Hartholzgestell aus Buche, gedübelt und verleimt.

② **Unterfederung**
Stahlwellenunterfederung mit Spezialabdeckung aus hochwertigem Futterstoff.

③ **Sitzkissen**
Daunencharakter
Comfort SL
Kaltschaumkombination
Taschenfederkern
Comfort Plus

④ **Rückenkissen**
Daunencharakter
Comfort SL
Kaltschaumkombination

Sitztiefen
Sitztiefe 53 cm
Sitztiefe 58 cm
Sitztiefe 62 cm

Sitzhöhen
Sitzhöhe 43 cm
Sitzhöhe 46 cm
Sonderhöhen möglich

⑤ **Fussausführungen**

Gestell Hartholzgestell aus Buche, gedübelt und verleimt.

Unterfederung Stahlwellenunterfederung mit Spezialabdeckung und hochwertigem Futterstoff.

Sitzkissen A Daunencharakter
Legere Ausführung in bewährter Kammerkissenverarbeitung und stabilisierendem Sitzkern aus Polyetherschaum RG 43. Füllung Polyschaumstäbchen mit hochwertigen Vliesfasern.

B Comfort SL
Weiche besonders anpassungsfähige Ausführung mit stabilisierendem Sitzkern aus Polyetherschaum RG 42. Füllung Polyschaumstäbchen in bewährter Kammerkissenverarbeitung.

C Kaltschaumkombination
Festere Ausführung aus hochwertiger Kaltschaumkombination. Formstabil durch festen Polyetherkern RG 43 und angenehm weicher Kaltschaumabdeckung RG 35.

D Taschenfederkern mit Daunencharakter
Klassischer Sitzkomfort durch einzeln in Taschen eingenähte zylindrische Federkerne, die mit hochwertigem Kaltschaum RG 40 ummantelt sind. Legere Oberfläche durch bewährte Kammerkissenverarbeitung. Füllung Polyschaumstäbchen RG 40. **Aufpreis siehe Sonderanfertigungen.**

G Comfort Plus
legere Ausführung in bewährter Stegmattenverarbeitung mit stabilisierendem Kern aus Kaltschaum RG 50. Füllung Polyschaumstäbchen mit hochwertigen Vliesfasern. **Aufpreis siehe Sonderanfertigungen.**

Sitztiefen
Sitztiefe 53 cm
Sitztiefe 58 cm (Mehrpreis 8 %)
Sitztiefe 62 cm (Mehrpreis 10 %)

Sitzhöhen
Sitzhöhe 43 cm
Sitzhöhe 46 cm
Durch Verlängerung des Seitenteils ohne Aufpreis.

Bitte Sitztiefe und Sitzhöhe bei der Bestellung unbedingt angeben.

Rückenkissen A Daunencharakter
Legere Ausführung in bewährter Kammerkissenverarbeitung. Füllung aus Polyschaumstäbchen und hochwertigen Vliesfasern.

B Comfort SL
Weiche besonders anpassungsfähige Ausführung in bewährter Kammerkissen-Verarbeitung. Füllung aus hochwertigen Vliesfaserkugeln.

C Kaltschaum
Formstabiler Kern aus hochwertigem Kaltschaum RG 50. Abdeckung aus Polyetherschaum RG 20 mit Vlieskaschierung.

CL 650

Produktumfang

CLASSICS

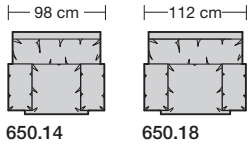

650.14 650.18

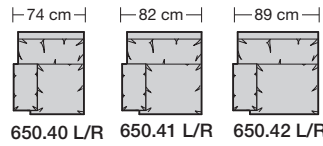

650.40 L/R 650.41 L/R 650.42 L/R

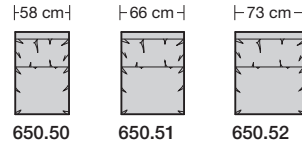

650.50 650.51 650.52

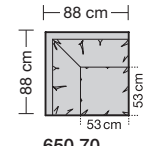

650.70

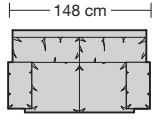

650.22

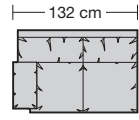

650.44 L/R

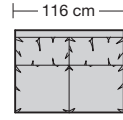

650.54

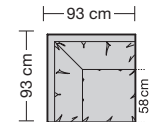

650.70 Übertief für Sitztiefe 58 cm

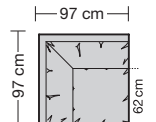

650.70 Übertief für Sitztiefe 62 cm

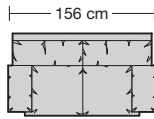

650.23

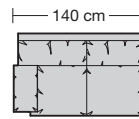

650.45 L/R

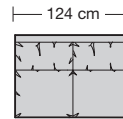

650.55

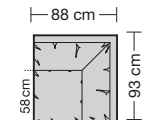

650.761 L

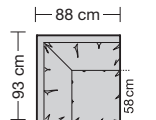

650.761 R

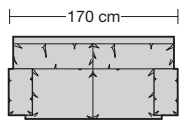

650.24

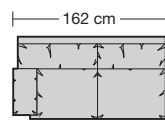

650.46 L/R

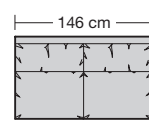

650.56

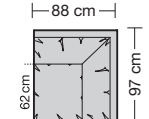

650.76 L

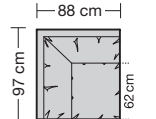

650.76 R

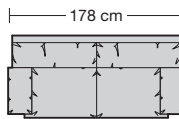

650.25

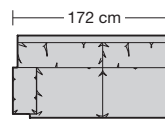

650.47 L/R

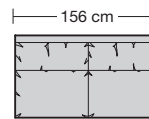

650.57

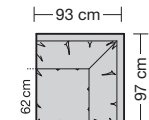

650.762 L

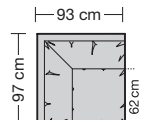

650.762 R

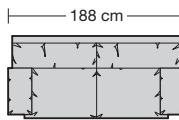

650.26

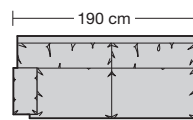

650.48 L/R

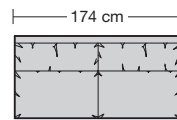

650.58

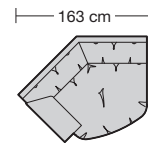

650.74 L

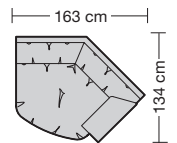

650.74 R

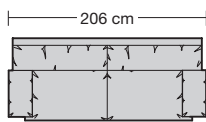

650.27

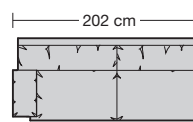

650.49 L/R

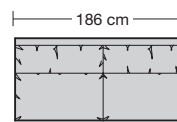

650.59

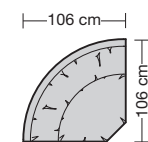

650.73

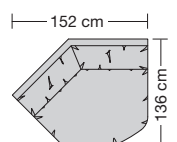

650.71

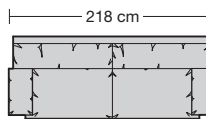

650.28

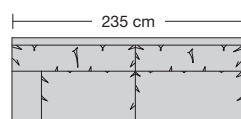

650.495 L/R

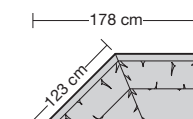

650.75

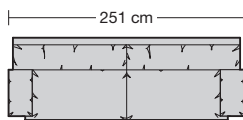

650.29

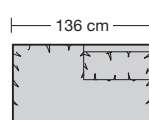

650.67 L/R

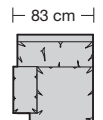

650.78 L/R

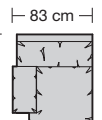

650.79 L/R

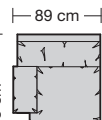

650.792 L/R

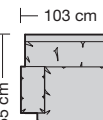

650.795 L/R

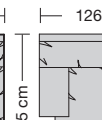

650.798 L/R

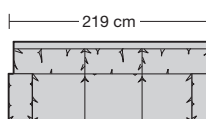

650.32

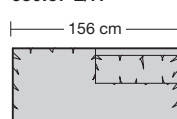

650.69 L/R

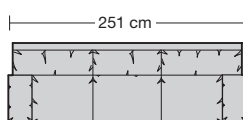

650.35

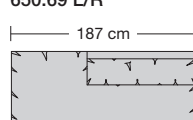

650.695 L/R

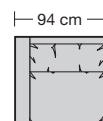

650.772 L/R

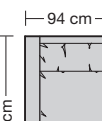

650.775 L/R

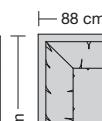

650.752 L/R

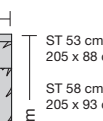

650.755 L/R

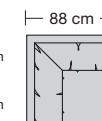

650.755 L/R

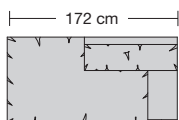

650.250 L/R

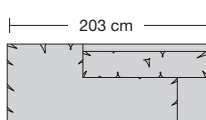

650.270 L/R

ST 53 cm = 205 x 88 cm

ST 58 cm = 205 x 93 cm

ST 62 cm = 205 x 97 cm

ST 53 cm = 225 x 88 cm

ST 58 cm = 225 x 93 cm

ST 62 cm = 225 x 97 cm

Sitztiefe, Sitzhöhe, Armlehne und Kissenführung bitte bei der Bestellung unbedingt angeben.

Füsse



Fuss Aluminiumguss oval, 37 x 25 mm,
CL7: 125 mm hoch für **Sitzhöhe 43 cm**,
CL75: 155 mm hoch für **Sitzhöhe 46 cm**
hochglanz poliert, matt poliert oder schwarz matt pulverbeschichtet

CL 7/75



Holzfuß mit Metallteller in Chrom hochglanz oder schwarz matt pulverbeschichtet. Ø 50 mm in allen Erpo Basisfarben. Sonderfarben gegen Aufpreis.
CL12: 130 mm hoch für **Sitzhöhe 43 cm**
CL125: 160 mm hoch für **Sitzhöhe 46 cm**
CL126: 180 mm hoch für **Sitzhöhe 48 cm**

CL 12 / 125 / 126



Holzfuß Buche mit Chromplatte, 142 x 142 mm
 Buche natur oder in allen Erpo Basisfarben. Sonderfarben gegen Aufpreis.
CL26: 130 mm hoch für **Sitzhöhe 43 cm**
CL265: 160 mm hoch für **Sitzhöhe 46 cm**

CL 26 / 265



Metallfuß rund, Ø 40 mm
hochglanz verchromt oder matt verchromt
CL30: 130 mm hoch für **Sitzhöhe 43 cm**
CL305: 160 mm hoch für **Sitzhöhe 46 cm**

CL 30 / 305



Metall Flachstahl, hochglanz verchromt
CL35: 130 mm hoch für **Sitzhöhe 43 cm**
CL355: 160 mm hoch für **Sitzhöhe 46 cm**

CL 35 / 355



Holzfuß Buche rund, Ø 60 mm
 Buche natur, Eiche natur oder in allen Erpo Basisfarben. Sonderfarben gegen Aufpreis.
CL40: 130 mm hoch für **Sitzhöhe 43 cm**
CL405: 160 mm hoch für **Sitzhöhe 46 cm**
CL406: 180 mm hoch für **Sitzhöhe 48 cm**

CL 40 / 405 / 406



Holzfuß Buche, 90 x 90 mm, in allen Erpo Basisfarben. Sonderfarben gegen Aufpreis oder in **Eiche natur**.
CL48: 130 mm hoch für **Sitzhöhe 43 cm**
CL485: 160 mm hoch für **Sitzhöhe 46 cm**

CL 48 / 485



Metallfuß rund, Ø 60 mm
hochglanz verchromt, matt verchromt oder schwarz matt pulverbeschichtet.
CL50: 130 mm hoch für **Sitzhöhe 43 cm**
CL505: 160 mm hoch für **Sitzhöhe 46 cm**
CL506: 180 mm hoch für **Sitzhöhe 48 cm**

CL 50 / 505 / 506



Metallfuß diagonal angeordnet, 30-44 mm
hochglanz verchromt, matt verchromt oder schwarz matt pulverbeschichtet.
CL57: 130 mm hoch für **Sitzhöhe 43 cm**
CL575: 160 mm hoch für **Sitzhöhe 46 cm**

CL 57 / 575



Fuss Aluminiumguss oval, **hochglanz poliert oder schwarz matt pulverbeschichtet** Ø 16-29 mm
CL59: 130 mm hoch für **Sitzhöhe 43 cm**
CL595: 160 mm hoch für **Sitzhöhe 46 cm**
 Bei Parkett kann dieser Fuss zu Abdrücken führen.

CL 59 / 595



Aluminium natur, Ø 40 mm
CL60: 130 mm hoch für **Sitzhöhe 43 cm**
CL605: 160 mm hoch für **Sitzhöhe 46 cm**

CL 60 / 605



Metallfuß rund, höhenverstellbar von 130 - 155 mm, für **Sitzhöhe 43 - 45 cm**, Ø 30 mm, **hochglanz verchromt, titanfarbig oder schwarz matt pulverbeschichtet.**
 Sonderlackierung in allen RAL Farben gegen Aufpreis.

CL 80



Kufe Buche, 50 x 30 mm, 130, 160 oder 180 mm hoch. In allen Erpo Basisfarben. Sonderfarben gegen Aufpreis oder in Eiche natur für **Sitzhöhe 43, 46 oder 48 cm**

Aufpreis pro Kufe in Buche in Eiche

Kufe 2



Metall quadratisch, 30 x 30 mm, 130 oder 150 mm hoch, für **Sitzhöhe 43 oder 45 cm**, **hochglanz verchromt oder matt verchromt.**

Aufpreis pro Kufe

Kufe 3



Metall Flachstahl, 50 mm breit, 130 oder 150 mm hoch, für **Sitzhöhe 43 oder 45 cm**, **hochglanz verchromt, matt verchromt oder schwarz matt pulverbeschichtet.**
 Kufe immer mittig unter Armlehne montiert.

Aufpreis pro Kufe in chrom in schwarz

Kufe 5











Metall Flachstahl, 80 mm breit, 130 oder 150 mm hoch, für **Sitzhöhe 43 oder 45 cm**, **hochglanz verchromt, matt verchromt oder schwarz matt pulverbeschichtet**
 Kufe immer mittig unter Armlehne montiert.

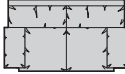
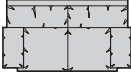

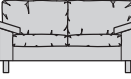

Aufpreis pro Kufe in chrom in schwarz

Kufe 8



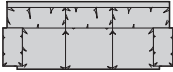
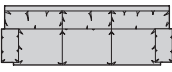
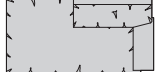
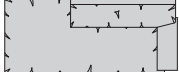

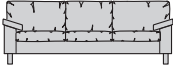
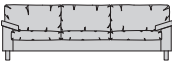
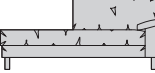
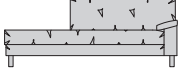
CL 650

Sitztiefe, Sitzhöhe, Armlehne und Kissenausführung bitte bei der Bestellung unbedingt angeben.					
					
	Sessel	Sessel	Sofa 2-sitzig	Sofa 2-sitzig	Sofa 2-sitzig
Breite	98 cm	112 cm	148 cm	156 cm	170 cm
Bestell-Nr.	650.14	650.18	650.22	650.23	650.24
Sitztiefe 53 cm					
Sitztiefe 58 cm / 8 % Aufpreis					
Sitztiefe 62 cm / 10 % Aufpreis					
Stoffgruppe	13				
	14				
	15				
	16				
	17				
	18				
	19				
	20				
Ledergruppe					
	Ledergruppe D				
(Leder 170)	Ledergruppe E				
	Ledergruppe F				
(Leder 190)	Ledergruppe G				
	Ledergruppe H				
(Leder 43)	Ledergruppe I				
(Leder 42)	Ledergruppe J				
(Leder 250)	Ledergruppe K				
(Leder 430/45)	Ledergruppe L				
(Leder 390)	Ledergruppe M				
(Leder 450)	Ledergruppe N				
(Leder 550)	Ledergruppe O				
	Ledergruppe P				
	Ledergruppe Q				
Stoffbedarf, ohne Rapport					
140 cm breit	5.90 m	6.20 m	7.40 m	7.80 m	8.05 m

CL 650

Sitztiefe, Sitzhöhe, Armlehne und Kissenausführung bitte bei der Bestellung unbedingt angeben.					
					
	Sofa 3-sitzig	Sofa 3-sitzig	Sofa mit offenem Abschluss	Sofa mit offenem Abschluss	Anreihenelement
Breite	219 cm	251 cm	172 cm	203 cm	74 cm
Bestell-Nr.	650.32	650.35	650.250 L/R	650.270 L/R	650.40 L/R
Sitztiefe 53 cm					
Sitztiefe 58 cm / 8 % Aufpreis					
Sitztiefe 62 cm / 10 % Aufpreis					
Stoffgruppe	13				
	14				
	15				
	16				
	17				
	18				
	19				
	20				
Ledergruppe					
	Ledergruppe D				
(Leder 170)	Ledergruppe E				
	Ledergruppe F				
(Leder 190)	Ledergruppe G				
	Ledergruppe H				
(Leder 43)	Ledergruppe I				
(Leder 42)	Ledergruppe J				
(Leder 250)	Ledergruppe K				
(Leder 430/45)	Ledergruppe L				
(Leder 390)	Ledergruppe M				
(Leder 450)	Ledergruppe N				
(Leder 550)	Ledergruppe O				
	Ledergruppe P				
	Ledergruppe Q				
Stoffbedarf, ohne Rapport					
140 cm breit	9.90 m	11.00 m	6.00 m	6.70 m	3.95 m

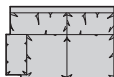
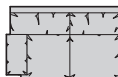
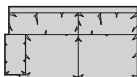
CL 650

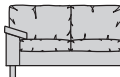
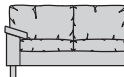
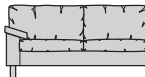

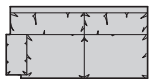
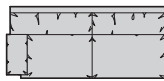
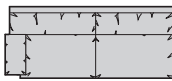
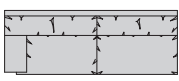
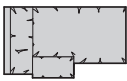
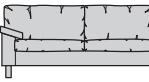
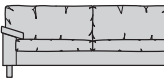
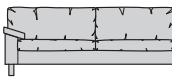
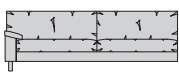
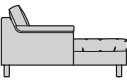

Sitztiefe, Sitzhöhe, Armlehne und Kissenführung bitte bei der Bestellung unbedingt angeben.					
					
	Anreihelement	Anreihelement	Anreihsofa 2-sitzig	Anreihsofa 2-sitzig	Anreihsofa 2 1/2-sitzig
Breite	82 cm	89 cm	132 cm	140 cm	162 cm
Bestell-Nr.	650.41 L/R	650.42 L/R	650.44 L/R	650.45 L/R	650.46 L/R
Sitztiefe 53 cm					
Sitztiefe 58 cm / 8 % Aufpreis					
Sitztiefe 62 cm / 10 % Aufpreis					
Stoffgruppe	13				
	14				
	15				
	16				
	17				
	18				
	19				
	20				
Ledergruppe					
	Ledergruppe D				
(Leder 170)	Ledergruppe E				
	Ledergruppe F				
(Leder 190)	Ledergruppe G				
	Ledergruppe H				
(Leder 43)	Ledergruppe I				
(Leder 42)	Ledergruppe J				
(Leder 250)	Ledergruppe K				
(Leder 430/45)	Ledergruppe L				
(Leder 390)	Ledergruppe M				
(Leder 450)	Ledergruppe N				
(Leder 550)	Ledergruppe O				
	Ledergruppe P				
	Ledergruppe Q				
Stoffbedarf, ohne Rapport					
140 cm breit	4.20 m	4.35 m	6.00 m	6.40 m	7.20 m

CL 650

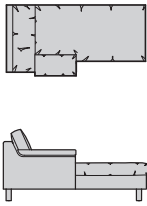
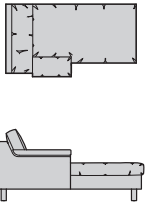
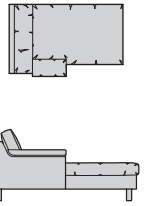
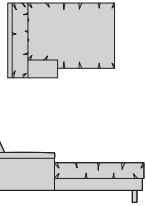
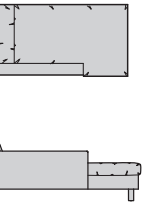

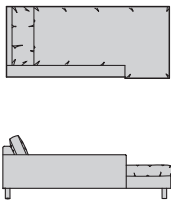
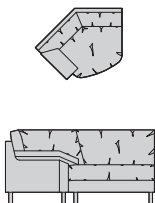



Sitztiefe, Sitzhöhe, Armlehne und Kissenausführung bitte bei der Bestellung unbedingt angeben.					
					
	Anreihsofa 2 1/2-sitzig	Anreihsofa 2 1/2-sitzig	Anreihsofa 2 1/2-sitzig	Anreihsofa 2 1/2-sitzig	Longchair
Breite	172 cm	190 cm	202 cm	235 cm	83 x 145 cm
Bestell-Nr.	650.47 L/R	650.48 L/R	650.49 L/R	650.495 L/R	650.78 L/R
Sitztiefe 53 cm					
Sitztiefe 58 cm / 8 % Aufpreis					
Sitztiefe 62 cm / 10 % Aufpreis					
Stoffgruppe	13				
	14				
	15				
	16				
	17				
	18				
	19				
	20				
Ledergruppe					
	Ledergruppe D				
(Leder 170)	Ledergruppe E				
	Ledergruppe F				
(Leder 190)	Ledergruppe G				
	Ledergruppe H				
(Leder 43)	Ledergruppe I				
(Leder 42)	Ledergruppe J				
(Leder 250)	Ledergruppe K				
(Leder 430/45)	Ledergruppe L				
(Leder 390)	Ledergruppe M				
(Leder 450)	Ledergruppe N				
(Leder 550)	Ledergruppe O				
	Ledergruppe P				
	Ledergruppe Q				
Stoffbedarf, ohne Rapport					
140 cm breit	7.40 m	7.80 m	8.00 m	8.40 m	5.70 m

CL 650

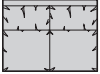
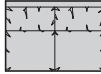
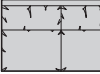
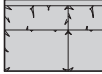
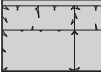
Sitztiefe, Sitzhöhe, Armlehne und Kissenführung bitte bei der Bestellung unbedingt angeben.					
	Longchair	Longchair	Longchair	Longchair	Ecksofa Rückenarmlehne 16 cm
Breite	83 x 165 cm	89 x 165 cm	103 x 165 cm	126 x 180 cm	94 x 192 cm
Bestell-Nr.	650.79 L/R	650.792 L/R	650.795 L/R	650.798 L/R	650.772 L/R
Sitztiefe 53 cm					
Sitztiefe 58 cm / 8 % Aufpreis					
Sitztiefe 62 cm / 10 % Aufpreis					
Stoffgruppe	13				
	14				
	15				
	16				
	17				
	18				
	19				
	20				
Ledergruppe					
	Ledergruppe D				
(Leder 170)	Ledergruppe E				
	Ledergruppe F				
(Leder 190)	Ledergruppe G				
	Ledergruppe H				
(Leder 43)	Ledergruppe I				
(Leder 42)	Ledergruppe J				
(Leder 250)	Ledergruppe K				
(Leder 430/45)	Ledergruppe L				
(Leder 390)	Ledergruppe M				
(Leder 450)	Ledergruppe N				
(Leder 550)	Ledergruppe O				
	Ledergruppe P				
	Ledergruppe Q				
Stoffbedarf, ohne Rapport					
140 cm breit	5.90 m	6.20 m	6.60 m	7.20 m	6.10 m

Sitztiefe, Sitzhöhe, Armlehne und Kissenausführung bitte bei der Bestellung unbedingt angeben.					
	Ecksofa Rückenarmlehne 16 cm	Loungeelement	Anbauelement	Anbauelement	Anbauelement
Breite	94 x 222 cm	163 x 134 cm	58 cm	66 cm	73 cm
Bestell-Nr.	650.775 L/R	650.74 L/R	650.50	650.51	650.52
Sitztiefe 53 cm					
Sitztiefe 58 cm / 8 % Aufpreis					
Sitztiefe 62 cm / 10 % Aufpreis					
Stoffgruppe	13				
	14				
	15				
	16				
	17				
	18				
	19				
	20				
Ledergruppe					
	Ledergruppe D				
(Leder 170)	Ledergruppe E				
	Ledergruppe F				
(Leder 190)	Ledergruppe G				
	Ledergruppe H				
(Leder 43)	Ledergruppe I				
(Leder 42)	Ledergruppe J				
(Leder 250)	Ledergruppe K				
(Leder 430/45)	Ledergruppe L				
(Leder 390)	Ledergruppe M				
(Leder 450)	Ledergruppe N				
(Leder 550)	Ledergruppe O				
	Ledergruppe P				
	Ledergruppe Q				
Stoffbedarf, ohne Rapport					
140 cm breit	6.80 m	7.40 m	2.70 m	3.00 m	3.30 m

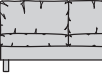





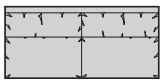
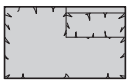
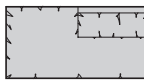
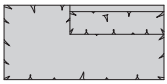
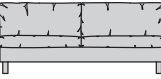
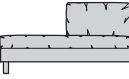
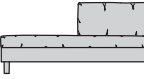
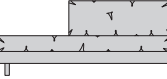



CL 650

Sitztiefe, Sitzhöhe, Armlehne und Kissenführung bitte bei der Bestellung unbedingt angeben.					
					
	Anbausofa 2-sitzig	Anbausofa 2-sitzig	Anbausofa 2 1/2-sitzig	Anbausofa 2 1/2-sitzig	Anbausofa 2 1/2-sitzig
Breite	116 cm	124 cm	146 cm	156 cm	174 cm
Bestell-Nr.	650.54	650.55	650.56	650.57	650.58
Sitztiefe 53 cm					
Sitztiefe 58 cm / 8 % Aufpreis					
Sitztiefe 62 cm / 10 % Aufpreis					
Stoffgruppe	13				
	14				
	15				
	16				
	17				
	18				
	19				
	20				
Ledergruppe					
	Ledergruppe D				
(Leder 170)	Ledergruppe E				
	Ledergruppe F				
(Leder 190)	Ledergruppe G				
	Ledergruppe H				
(Leder 43)	Ledergruppe I				
(Leder 42)	Ledergruppe J				
(Leder 250)	Ledergruppe K				
(Leder 430/45)	Ledergruppe L				
(Leder 390)	Ledergruppe M				
(Leder 450)	Ledergruppe N				
(Leder 550)	Ledergruppe O				
	Ledergruppe P				
	Ledergruppe Q				
Stoffbedarf, ohne Rapport					
140 cm breit	4.10 m	4.60 m	5.30 m	5.80 m	6.10 m









CL 650

Sitztiefe, Sitzhöhe, Armlehne und Kissenausführung bitte bei der Bestellung unbedingt angeben.					
					
	Anbausofa 2 1/2-sitzig	Abschlusselement mit Hocker	Abschlusselement mit Hocker	Abschlusselement mit Hocker	
Breite	186 cm	136 cm	156 cm	187 cm	
Bestell-Nr.	650.59	650.67 L/R	650.69 L/R	650.695 L/R	
Sitztiefe 53 cm					
Sitztiefe 58 cm / 8 % Aufpreis					
Sitztiefe 62 cm / 10 % Aufpreis					
Stoffgruppe	13				
	14				
	15				
	16				
	17				
	18				
	19				
	20				
Ledergruppe					
	Ledergruppe D				
(Leder 170)	Ledergruppe E				
	Ledergruppe F				
(Leder 190)	Ledergruppe G				
	Ledergruppe H				
(Leder 43)	Ledergruppe I				
(Leder 42)	Ledergruppe J				
(Leder 250)	Ledergruppe K				
(Leder 430/45)	Ledergruppe L				
(Leder 390)	Ledergruppe M				
(Leder 450)	Ledergruppe N				
(Leder 550)	Ledergruppe O				
	Ledergruppe P				
	Ledergruppe Q				
Stoffbedarf, ohne Rapport					
140 cm breit	6.20 m	5.30 m	5.80 m	5.90 m	

CL 650

Sitztiefe, Sitzhöhe, Armlehne und Kissenführung bitte bei der Bestellung unbedingt angeben.					
					
	Eckelement ST 53 / 53	Eckelement ST 58 / 58	Eckelement ST 62 / 62	Eckelement ST 53 / 58	Eckelement ST 58 / 53
Breite	88 x 88 cm	93 x 93 cm	97 x 97 cm	88 x 93 cm	88 x 93 cm
Bestell-Nr.	650.70	650.70	650.70	650.761 L	650.761 R
Sitztiefe 53 cm					
Sitztiefe 58 cm / 8 % Aufpreis					
Sitztiefe 62 cm / 10 % Aufpreis					
Stoffgruppe	13				
	14				
	15				
	16				
	17				
	18				
	19				
	20				
Ledergruppe					
	Ledergruppe D				
(Leder 170)	Ledergruppe E				
	Ledergruppe F				
(Leder 190)	Ledergruppe G				
	Ledergruppe H				
(Leder 43)	Ledergruppe I				
(Leder 42)	Ledergruppe J				
(Leder 250)	Ledergruppe K				
(Leder 430/45)	Ledergruppe L				
(Leder 390)	Ledergruppe M				
(Leder 450)	Ledergruppe N				
(Leder 550)	Ledergruppe O				
	Ledergruppe P				
	Ledergruppe Q				
Stoffbedarf, ohne Rapport					
140 cm breit	4.70 m	4.90 m	5.00 m	5.00 m	5.00 m

CL 650

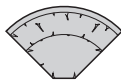
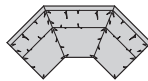
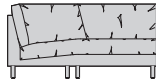
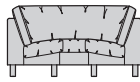
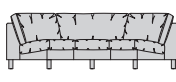

Sitztiefe, Sitzhöhe, Armlehne und Kissenausführung bitte bei der Bestellung unbedingt angeben.					
					
	Eckelement ST 53 / 62	Eckelement ST 62 / 53	Eckelement ST 58 / 62	Eckelement ST 62 / 58	
Breite	88 x 97 cm	88 x 97 cm	93 x 97 cm	93 x 97 cm	
Bestell-Nr.	650.76 L	650.76 R	650.762 L	650.762 R	
Sitztiefe 53 cm					
Sitztiefe 58 cm / 8 % Aufpreis					
Sitztiefe 62 cm / 10 % Aufpreis					
Stoffgruppe	13				
	14				
	15				
	16				
	17				
	18				
	19				
	20				
Ledergruppe					
	Ledergruppe D				
(Leder 170)	Ledergruppe E				
	Ledergruppe F				
(Leder 190)	Ledergruppe G				
	Ledergruppe H				
(Leder 43)	Ledergruppe I				
(Leder 42)	Ledergruppe J				
(Leder 250)	Ledergruppe K				
(Leder 430/45)	Ledergruppe L				
(Leder 390)	Ledergruppe M				
(Leder 450)	Ledergruppe N				
(Leder 550)	Ledergruppe O				
	Ledergruppe P				
	Ledergruppe Q				
Stoffbedarf, ohne Rapport					
140 cm breit	5.00 m	5.00 m	5.00 m	5.00 m	

CL 650

Sitztiefe, Sitzhöhe, Armlehne und Kissenführung bitte bei der Bestellung unbedingt angeben.					
					
	Loungeeckelement	Rundeckelement 90°	Trapezeckelement		
Breite	152 x 136 cm	106 x 106 cm	178 x 178 cm		
Bestell-Nr.	650.71	650.73	650.75		
Sitztiefe 53 cm					
Sitztiefe 58 cm / 8 % Aufpreis					
Sitztiefe 62 cm / 10 % Aufpreis					
Stoffgruppe	13				
	14				
	15				
	16				
	17				
	18				
	19				
	20				
Ledergruppe					
	Ledergruppe D				
(Leder 170)	Ledergruppe E				
	Ledergruppe F				
(Leder 190)	Ledergruppe G				
	Ledergruppe H				
(Leder 43)	Ledergruppe I				
(Leder 42)	Ledergruppe J				
(Leder 250)	Ledergruppe K				
(Leder 430/45)	Ledergruppe L				
(Leder 390)	Ledergruppe M				
(Leder 450)	Ledergruppe N				
(Leder 550)	Ledergruppe O				
	Ledergruppe P				
	Ledergruppe Q				
Stoffbedarf, ohne Rapport					
140 cm breit	5.70 m	4.70 m	8.00 m		

CL 650

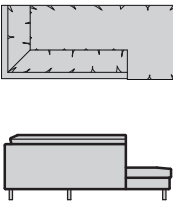
Eckabschlusselement

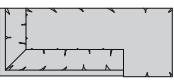
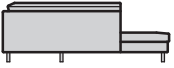
<p>Bitte beachten Sie, dass das Eckabschlusselement nur in der Sitztiefe des angebauten Elementes geliefert werden kann!</p>	 	 			
<p>Breite</p>	<p>Eckabschluss- element 205 cm</p>	<p>Eckabschluss- element 225 cm</p>			
<p>Bestell-Nr.</p>	<p>650.752 L/R</p>	<p>650.755 L/R</p>			
<p>Sitztiefe 53 cm</p>					
<p>Sitztiefe 58 cm / 8 % Aufpreis</p>	<p>Bitte beachten Sie die Informationen oben links.</p>				
<p>Sitztiefe 62 cm / 10 % Aufpreis</p>					
<p>Stoffgruppe</p>	<p>13 14 15 16 17 18 19 20</p>				
<p>Ledergruppe</p>	<p>Ledergruppe D (Leder 170) Ledergruppe E Ledergruppe F (Leder 190) Ledergruppe G Ledergruppe H (Leder 43) Ledergruppe I (Leder 42) Ledergruppe J (Leder 250) Ledergruppe K (Leder 430/45) Ledergruppe L (Leder 390) Ledergruppe M (Leder 450) Ledergruppe N (Leder 550) Ledergruppe O Ledergruppe P Ledergruppe Q</p>				
<p>Stoffbedarf, ohne Rapport</p>					
<p>140 cm breit</p>	<p>7.30 m</p>	<p>7.70 m</p>			